

TS510 & TS500

Installation & User Guide

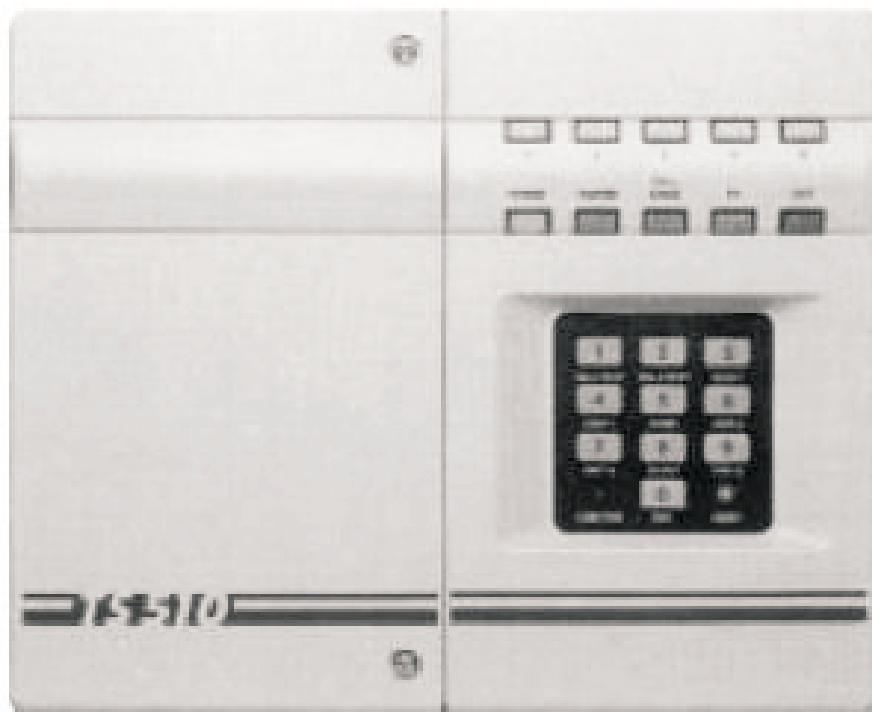

Compatible Equipment

TS510 REM - Remote Keypad
9040 - Loudspeaker
DC54/58 - Digital Communicator
SD1+ - Speech Dialler

Overview

Introduction

This installation manual is intended to help you install the TS510 as quickly and easily as possible. It is therefore very important to read the manual thoroughly *before* starting any work. This is particularly significant if it is your first TS510 installation.

The TS500 was the predecessor to the TS510. The differences between the two panels are noted throughout this guide.

Specification

5 Programmable Zones with individual Tamper circuits, plus fixed PA and Exit Terminator Outputs for Bell, Strobe and 16 Ohm Loudspeaker

Optional Remote Keypad (1 only) and Keyswitch

Plug-on digicom DC3 or plug-on interface (TS500/510.IF) for connection to digicoms DC3, Redcare STU, Paknet etc.

Conforms to BS4737: Part 1: 1986

Input Voltage:	240V \pm 10% 50Hz
Panel DC Current:	30mA, 100mA in alarm
REM DC Current:	10mA
Current Available:	750mA MAX (AUX + Bell Current)
Battery Capacity:	12V, 2.6/3.2Ahr (batteries not supplied)
Dimensions:	W x H x D 260 x 213 x 85mm
Weight Panel	1.5Kg
Remote Keypad	125 x 127 x 32mm
Weight Keypad	200g
Environment:	0° - 55 C (INDOORS)

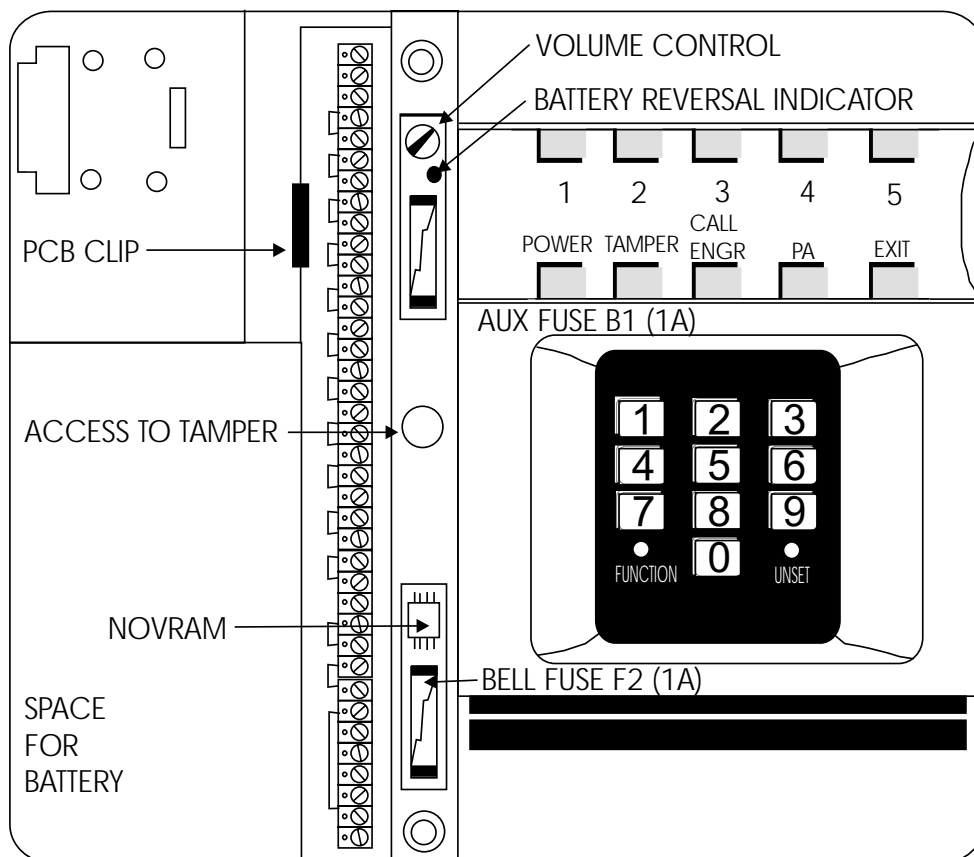

Figure 1 - TS510 Assembly Layout

System Wiring

All ZONE and TAMPER inputs are linked out prior to despatch from the factory. Remove these links from those zones which are to be used, but leave the links in unused zones. The EXIT TERMINATOR link **MUST BE REMOVED** even if this facility is not used, otherwise all programmed information will be lost on total power loss (mains and battery).

2. Ensure that the circuit, tamper and remote keypad cables are not routed adjacent to AC or RF cabling and are not run in multicore cables with bells or sounders.
3. Insulation testing should only be carried out when the cable under test is disconnected from electronic circuitry at both ends.

PLANNING AND INSTALLING THE WIRING:-

1. Ensure that the mains cable, circuit cables and telecom cables are kept separate, and that mains cable enters the housing as near to the fused terminal block as possible.

NOTE: TS500 Aux TMP = Main & Bell TMP

- OP1 = WLK TST
- OP2 = SW 12V

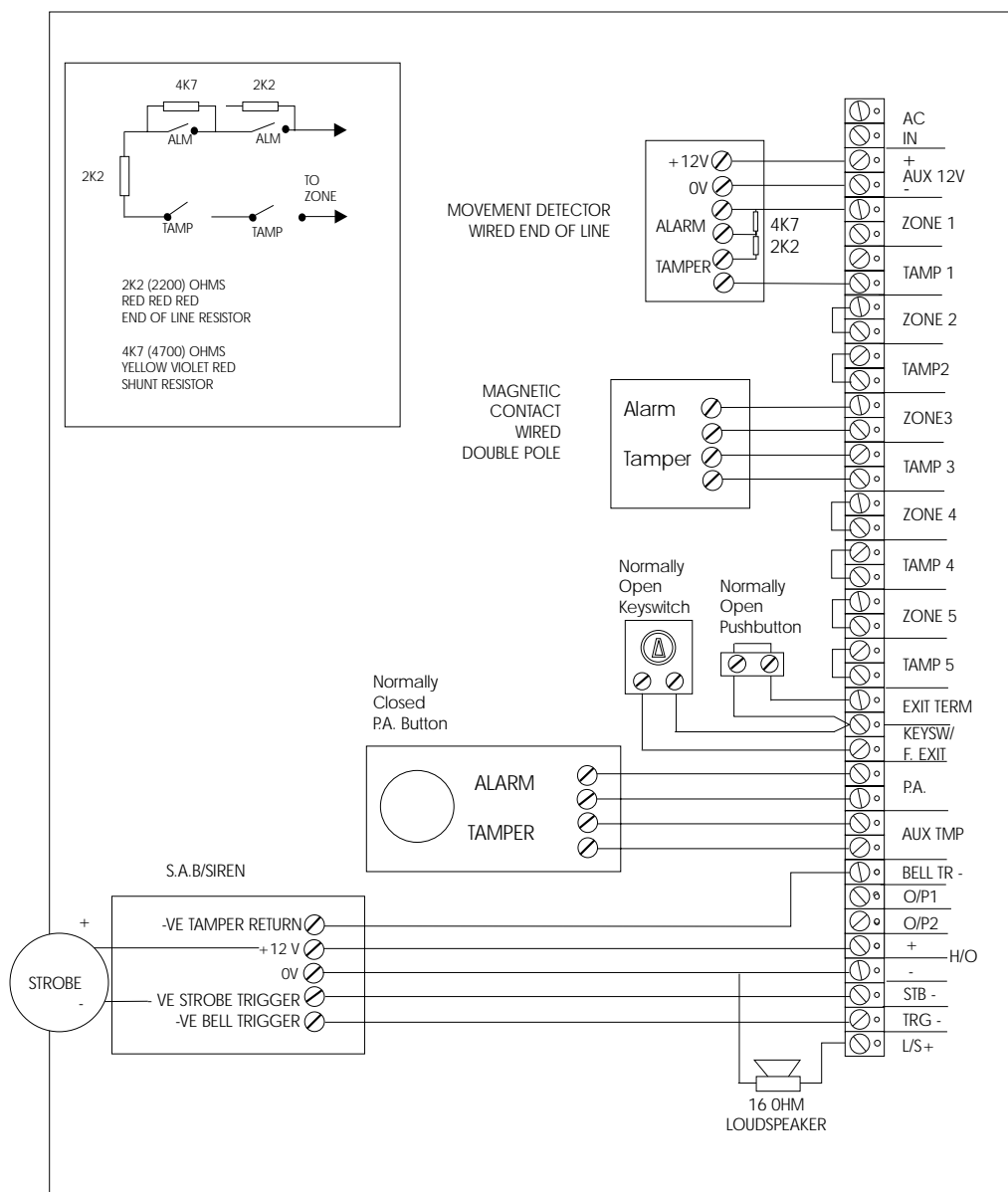

Fig 2 SAMPLE Wiring Diagram (showing Double Pole and End of Line Resistor wiring)

Remote Keypad

Up to 4 remote keypads (order code: TS510 REM), can be fitted, these are supplied with an interface which plugs onto the main panel PCB. The connections from the panel to the Remote Keypad require a five core cable (max length 50m).

Assuming that the control panel covers have been removed, the cable is in place and that the mains supply and backup battery have been disconnected, installation is as follows:

1. Connect the cable to the interface connections A, B, C etc, and then carefully locate the interface in the slot at the bottom of the panel PCB. Replace the right hand cover assembly.
2. Separate the remote keypad cover assembly from the base by releasing the clips on the top and bottom of the housing. Place the base on the wall where it is required and mark the screw positions. Remove the base then drill and plug the wall. Fix the base to the wall.
3. Taking care not to damage the PCB assembly, connect the terminal blocks on the remote keypad to the cable, ensuring that the connections through to the control panel interface card are A to A, B to B etc.
4. Carefully re-attach the front cover assembly to the base ensuring that the cable is clear of the spring on the tamper switch, and the cover is securely clipped to the base. Finally re-connect the mains supply and test the operation of the remote keypad.
5. If more than 1 remote keypad is to be used, connections may be in a star or daisy chain configuration.

NOTE: *TS500 only compatible with TS500 REM.*

NOTE: *TS500 only, link (LKI). If open the remote keypad will have full functions if closed you can only use remote keypad to set, part set and unset.*

NOTE: *TS500 Only one remote keypad can be fitted*

Digital Communicator

The DC3 is an 8 channel plug-on digital communicator specifically designed to operate with Menvier Security control panels, and is supplied with a lead for connection directly onto the main panel PCB. The unit has its own installation and programming instructions which must be referred to before proceeding with installation. The digital communicator is mounted behind the right hand lid assembly as appropriate.

CAUTION: The mains supply and backup battery must be disconnected before connecting the DC3 to the main PCB.

Other communication devices such as the DC28 Digicom, RedCARE STU, Pakent Interface Card etc. may be connected to the TS510 by using an optional interface card (TS510.IF). This is also supplied with its own installation instructions which should be referred to before proceeding with installation. Fig. 4 shows the TS510.IF connections when plugged onto the TS510 PCB. (See page 5)

TS510 Digital Communicator Wiring

TS500 Digital Communicator Wiring

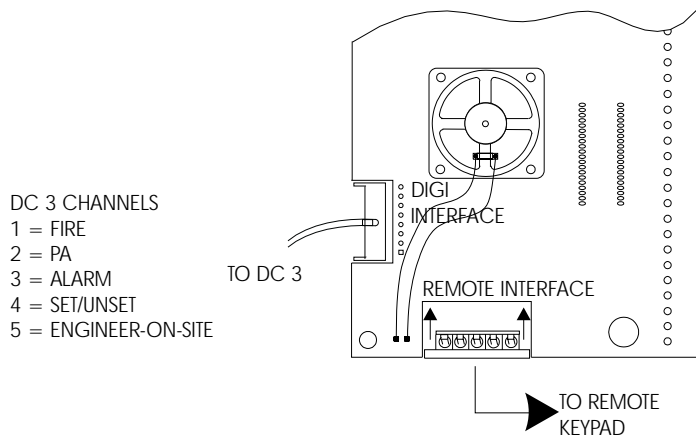

Fig 3 DC3 and TS510.REM Connections

Fit the DC3 connector to the TS510 plug as shown.

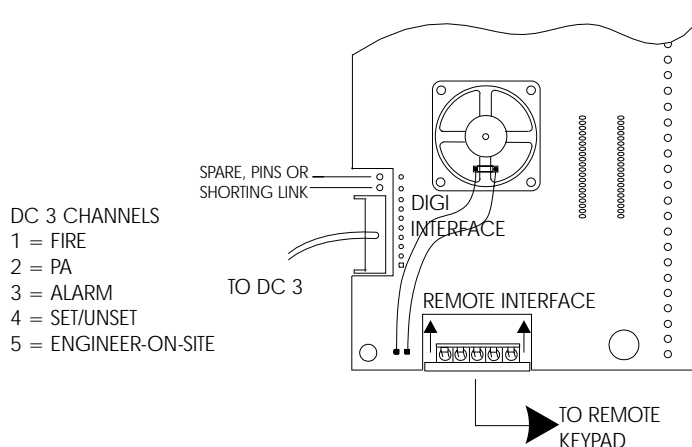

Fig 5 DC3 and TS500.REM Connections

Fit the DC3 connector to the TS500 plug after removing the polarity pin from socket 4. Ensure that the connector is fitted with the wings pointing away from the TS500 PCB, and the shorting link (or 2 spare pins) are above the connector.

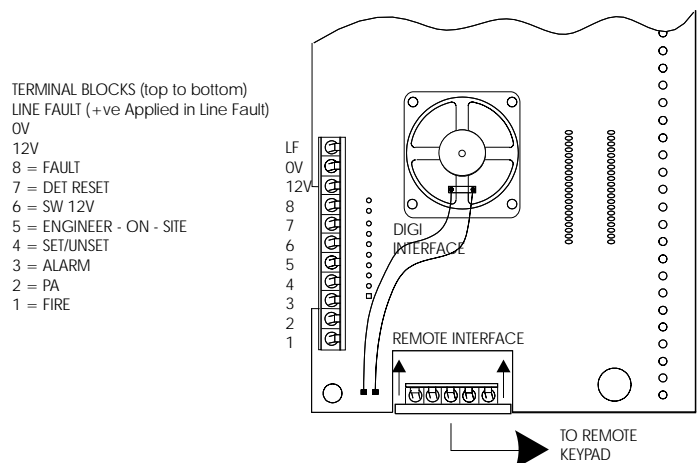

Fig4 TS510.IF and TS510.REM Connection

Fit the TS510.IF to the panel plug taking care to ensure that correct alignment is made and that no pins are visible.

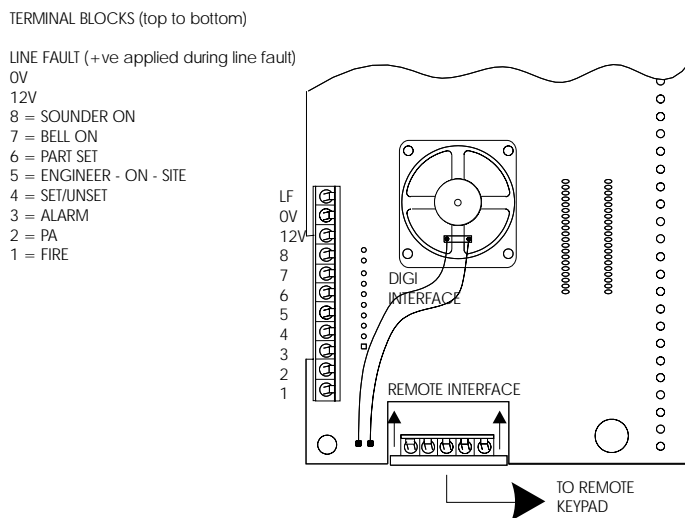

Fig 6 TS500/510.IF and TS500.REM Connections

Remove the shorting link (if fitted) from the top 2 pins of the DIGI INTERFACE connector. Fit the TS500/510.IF to the panel plug taking care to ensure that correct alignment is made and that no pins are visible.

Defaults

ENGINEER CODE	= 1234	OPTIONS 1: (NOT APPLICABLE TO TS500)
MASTER USER CODE	= 5678	Bell output is SAB
LAST EXIT ZONE	= ZONE 1	Alarm cleared on reset
ACCESS ZONE	= ZONE 2	Audible P.A.
EXIT TIME	= 30 secs.	P.A. audible in line fault
ENTRY TIME	= 30 secs.	Fire output signals during Full Set only
BELL DURATION	= 20 min.	Output 1 is WALK TEST
BELL DELAY	= 0 min.	Output 2 is SW12V
REMOTE RESET REF	= 004	KEY SW/F.EXIT input is full set keyswitch Set inhibited on mains fail
		OPTIONS 2: (NOT APPLICABLE TO TS500)
		Exit Terminator chimes
		Exit Terminator disabled
		Timed exit set
		Auto rearm
		User reset

Key Functions

Engineer's Reset

1. Enter Engineer code default 1234. The CALL ENGR LED will illuminate. You are now in Engineer mode.
2. Press **[0]** twice to return to unset.

Bell Test/Walk Test

Please refer to user function numbers 1 & 2 respectively.

Loading Defaults

1. Power down panel mains and battery.
2. Wire in a small piece of cable across two terminals for exit terminator.
3. Power up battery and mains.
4. Enter 1234 and remove link.
5. The panel is now back to Factory Default Programming.

Engineers Programming

ENTER ENGINEER CODE AND THE [CALL ENGR] LED WILL ILLUMINATE TOGETHER WITH THAT OF THE ZONE WHICH CREATED THE LAST ALARM. IF THE [CALL ENGR] LED FLASHES, THE LAST ALARM OCCURRED WITH A LINE FAULT PRESENT. OPTION DEFAULTS ARE SHOWN IN BOLD.

To program any of the zones (1 to 5) as standard NIGHT circuits, simply ensure that they are not programmed as Last Exit, Access or Fire.

To program any of the zones (1 to 5) as LAST EXIT circuits, press [1]. If any of the Zone LED's are ON, then these are already programmed with this option. To change zones simply enter the zone number, which will toggle the zone LED on/off. Once the setting is correct press [0] (END) and listen for the confirmation tone.

LED	1	2	3	4	5
LAST EXIT	ON/OFF	ON/OFF	ON/OFF	ON/OFF	ON/OFF

DEFAULT = ZONE 1 ONLY

To program any of the zones (1 to 5) as ACCESS circuits, press [2], If any of the Zone LED's are ON, then these are already programmed with this option. To change zones simply enter the zone number, which will toggle the zone LED on/off. Once the setting is correct press [0] (END) and listen for the confirmation tone.

LED	1	2	3	4	5
ACCESS:	ON/OFF	ON/OFF	ON/OFF	ON/OFF	ON/OFF

DEFAULT = ZONE 2 ONLY

To program any of the zones (1 to 5) as FIRE circuits, press [3]. If any of the Zone LED's are ON, then these are already programmed with this option. To change zones simply enter the zone number, which will toggle the zone LED on/off. Once the setting is correct press [0] (END) and listen for the confirmation tone

LED	1	2	3	4	5
ON FOR:	ON/OFF	ON/OFF	ON/OFF	ON/OFF	ON/OFF

NO DEFAULT ZONES

EXIT TIME: Press [4] and 3 zone LED's will light, indicating that a 3 digit exit time (in secs) is required, Once complete the confirmation tone will be heard. e.g. for 30 secs. enter 030

EXIT TIME				S
-----------	--	--	--	---

DEFAULT = 030 SECS

ENTRY TIME: Press [5] and 3 zone LED's will light, indicating that a 3 digit entry time (in secs) is required, Once complete the confirmation tone will be heard e.g. for 30 secs. enter 030

ENTRY TIME				S
------------	--	--	--	---

DEFAULT = 030 SECS

BELL DURATION:

Press [6] [1] and 3 zone LED's will light, indicating that a 3 digit bell duration time (in mins) is required. Once complete, the confirmation tone will be heard. e.g. for 20 mins, enter 020.

BELL DUR.				m
-----------	--	--	--	---

DEFAULT = 020 MINS

BELL DELAY:

Press [6] [2] and 3 zone LED's will light, indicating that a 3 digit bell delay time (in mins) is required. Once complete the confirmation tone will be heard. e.g. for 5 mins, enter 005

BELL DELAY				m
------------	--	--	--	---

DEFAULT = 000 MINS

OPTIONS: 63 - 69 Not applicable to TS500

SIGNALLING OPTIONS:

Press [6] [3] and combination of zone LED's will light, each showing a different setup:

LED	1	2	3	4	5
ON	BELL IS SAB	NO ALARM ABORT	AUDIBLE PA	PA AUDIBLE ON L.F	NOT USED
OFF	BELL IS SCB	ALARM ABORT	SILENT PA	PA SILENT ON LF	NOT USED

SIGNALLING OF FIRE:

Press [6] [4] and combination of zone LEDs will light, each showing a setup:

LED	1	2	3	4	5
ON = FIRE SIGNALLED	UNSET	PARTSET A	PARTSET B	FULL SET	NOT USED
IN:	ON/OFF	ON/OFF	ON/OFF	ON/OFF	NOT USED

OUTPUT 1:

Press [6] [5] and one of the following LEDs will light, showing which function is indicated by Output 1:

LED	1	2	3	4	5
ON FOR:	<i>WALK TEST</i>	SW12V	DTR RESET	ALARM	NOT USED
	ON/OFF	ON/OFF	ON/OFF	ON/OFF	NOT USED

OUTPUT 2:

Press [6] [6] and one of the following LEDs will light, showing which function is indicated by Output 2:

LED	1	2	3	4	5
ON FOR:	FAULT	SW 12V	DTR RESET	PA	NOT USED
	ON/OFF	ON/OFF	ON/OFF	ON/OFF	NOT USED

KEYSWITCH FINAL EXIT:

Press [6] [7] and one of the following LEDs will light, showing how the keyswitch input will operate.

LED	1	2	3	4	5
ON FOR:	FULL SET	PART SET A	PART SET B	FINAL EXIT	NOT USED
OFF FOR:	ON/OFF	ON/OFF	ON/OFF	ON/OFF	NOT USED

VIEW EVENT LOG:

Pressing [6] [8] will allow the event log to be viewed. Pressing [8] displays the last event whilst pressing numbers other than [9] and [0] displays earlier events in order, with [1] being the oldest event. To exit the routine, press [0].

SYSTEM SETTING OPTIONS:

Press (6) [9] to select the system setting options.

LED	1	2	3	4	5
ON FOR:	SET ALLOWED WITH MAINS FAILURE	RISING ENTRY AND EXIT TONES	SET ALLOWS WITH LINE FAULT	NOT USED	NOT USED
OFF FOR:	SET DISALLOWED WITH MAINS FAILURE	CONTINUOUS ENTRY AND EXIT TONES	SET DISALLOWED WITH LINE FAULT	NOT USED	NOT USED

ENGINEER CODE:

Press [7] and 4 zone LEDs will light indicating that a 4 digit engineer code is required. Once entered, re-enter the code for confirmation and listen for the confirmation tone.

ENGR CODE				
-----------	--	--	--	--

DEFAULT = 1234

REMOTE RESET CODE:

Press [8] and 3 zone LEDs will light, indicating that a 3 digit code must be entered. Enter your code and listen for the confirmation tone.

RESET NO.			
-----------	--	--	--

DEFAULT = 004

OPTIONS:

Press [9] and a combination of zone LEDs will light, each showing a different setup. To change any option, simply enter the number for the options required. Once the settings are correct, press [0] and listen for the confirmation tone.

LED	1	2	3	4	5
ON FOR:	ET/F EXIT SILENT	FINAL EXIT SET	E.T. ENABLED	ENGINEER RESET	3 REARMS
OFF FOR:	ET/F EXIT CHIMES	TIMED EXIT	E.T. DISABLED	USER RESET	0 REARMS

NOTE: Whilst in engineer mode, tampers are inhibited. To monitor tampers return the panel to the UNSET condition.

NOTE: OPTIONS: No.5 on TS500 LED ON = AUTO RE-ARM, LED OFF = MANUAL RE-ARM

User Functions

SETTING THE SYSTEM

1. Enter your passcode - the (UNSET) light will flash.
2. Wait 5 secs until the (FUNCTION) light goes out and the exit tone will start. Leave via the designated exit route, closing the door.
3. The system is set when the exit tone stops and the two tone confirmation tone is heard.

NOTES:

- A) If the exit tone continues and (if fitted) the strobe light on the bell box is flashing the system has not set and you must re-enter the premises, re-enter the passcode and start again.
- B) If you change your mind whilst setting the panel and wish to unset it again press (0) (END) or wait until the (FUNCTION) light goes out and re-enter your passcode.

PART SET THE SYSTEM

1. Enter your passcode - the (UNSET) light will flash
2. Press [7] (OMIT A) OR [9] (OMIT B) as appropriate - the zones omitted will flash.
3. After a pause the exit tone will start.
4. The system is part set when the exit tone stops.

The following options may be accessed by entering the USER 1 passcode IN REVERSE ORDER (eg for passcode 5678 - enter 8765) followed within 5 seconds by the function key you require. These facilities are not available to User 2 who is restricted to Set, Part-set and Unset activities.

NOTE: TS500 enter code in forwards and not in reverse for following functions

Testing Sounders

1. Enter User 1 passcode **IN REVERSE** and the tone will start - press [1] (BELL TEST) immediately.
2. All panel lights illuminate followed by 5 second sequential activations of internal sounders, external sounders and strobe (if fitted).
3. Panel returns to [UNSET] condition on completion of testing.

Testing Detectors

1. Enter User 1 passcode **IN REVERSE** and the tone will start - press [2] (WALK TEST) immediately.

2. Activate selected detectors or door contacts and smoke detectors if fitted.
3. Zone light illuminates and two tone sounder is heard for each device activated.
4. Press [0] (END) to complete test - [UNSET] will illuminate.

Change User 1 Passcode

1. Enter User 1 passcode **IN REVERSE** and the tone will start - press [4] (USER 1) immediately
2. Four zone lights illuminate and 15 seconds is allowed to commence entry of the new code.
3. Enter new passcode extinguishing the four zone lights.
4. Four zone lights illuminate again.
5. Repeat new passcode (as confirmation).
6. Two tone confirmation sound heard - new passcode accepted - [UNSET] will illuminate.

Change User 2 Passcode

1. Enter User 1 passcode **IN REVERSE** and the tone will start - press [6] (USER 2) immediately.
2. Four zone lights illuminate and 15 seconds is allowed to commence entry of the new code.
3. Enter new User 2 passcode extinguishing the four zone lights.
4. Four zone lights illuminate again.
5. Repeat new User 2 passcode (as confirmation).
6. Two tone confirmation sound heard - new User passcode accepted - [UNSET] will illuminate.

Selecting Chime

With the system unset you may wish to be alerted when door contacts or detectors are activated. You can set nominated devices to "CHIME":

1. Enter User 1 passcode **IN REVERSE** and the tone will start - press [5] (CHIME) immediately.
2. Any zones set to chime will illuminate.
3. To add or delete chime zones press the relevant zone number within 15 seconds.
4. Zone lights indicate status (LIT=CHIME, UNLIT=NORMAL).
5. When satisfied press [0] (END).
6. Two tone confirmation sound heard - [UNSET] will illuminate.

Change Part Set Areas

If you wish to re-arrange your part-set areas:

1. Enter User 1 passcode **IN REVERSE** and the tone will start - press [7] (OMIT A) OR [9] (OMIT B) immediately as required.
2. Zone lights flashing indicate those zones **omitted**
3. To add or delete omit zones press the relevant zone number within 15 seconds.
4. Zone lights indicate status

(FLASHING=OMITTED, UNLIT=NORMAL)

5. When satisfied press [0] (END).
6. Two tone confirmation sound heard - [UNSET] will illuminate.

Fault finding

[CALL ENGR] flashing

Indicates there is a telephone line problem if you are connected to a monitoring station. Check telephone and call engineer.

[CALL ENGR] illuminated

Try re-set procedures or call engineer.

[TAMPER] illuminated or flashing

The panel sounder will probably be bleeping and a zone light: may be flashing.

1. Enter passcode to stop sounder
2. Check detection devices in zone indicated
3. If you can correct the fault do so and then enter your passcode and press [0] (END). System returns to UNSET
4. If fault cannot be remedied - call your engineer.

(PA) illuminated

1. Manually reset Panic button with the key provided
2. Enter your passcode - PA indicator on
3. Enter your passcode and press [0] (END).

[POWER] light out

This will occur if there is a mains failure or power cut when the system will switch to reserve battery power for about 8 hours. If the power cut persists the system will go into alarm. If this happens enter your passcode to unset the system and call your engineer.