

DIGITAL VIDEO RECORDER: 4-, 9- AND 16-CHANNEL MODELS AHDR4, AHDR9 & AHDR16 USER'S MANUAL

Duplex mode (Simultaneous recording and playback)

Record speed up to 60ips for NTSC (50ips for PAL)

Highly efficient compression engine maximizes recording duration

Various recording modes (Time-lapse recording / Event recording)

Quick and easy search modes

Single-channel audio recording

Video archiving via USB interface

Powerful alarm handling

Multiple types of remote access (PSTN, ISDN, ADSL, LAN)



DIGITAL VIDEO RECORDER: 4-, 9- AND 16-CHANNEL MODELS AHDR4, AHDR9 & AHDR16 USER'S MANUAL

Duplex mode (Simultaneous recording and playback)

Record speed up to 60ips for NTSC (50ips for PAL)

Highly efficient compression engine maximizes recording duration

Various recording modes (Time-lapse recording / Event recording)



Quick and easy search modes

Single-channel audio recording

Video archiving via USB interface

Powerful alarm handling

Multiple types of remote access (PSTN, ISDN, ADSL, LAN)

	WARNING RISK OF ELECTRIC SHOCK DO NOT OPEN	
WARNING: TO REDUCE THE RISK OF ELECTRIC SHOCK, DO NOT REMOVE COVER (OR BACK). NO USER-SERVICEABLE PARTS INSIDE. REFER SERVICING TO QUALIFIED SERVICE PERSONNEL.		



The lightning flash with arrowhead symbol, within an equilateral triangle, is intended to alert the user to the presence of uninsulated "dangerous voltage" within the product's enclosure that may be of sufficient magnitude to constitute a risk of electric shock.



The exclamation point within an equilateral triangle is intended to alert the user to the presence of important operating and maintenance (servicing) instructions in the literature accompanying the appliance.

COMPLIANCE NOTICE OF FCC:

THIS EQUIPMENT HAS BEEN TESTED AND FOUND TO COMPLY WITH THE LIMITS FOR A CLASS A DIGITAL DEVICE, PURSUANT TO PART 15 OF THE FCC RULES. THESE LIMITS ARE DESIGNED TO PROVIDE REASONABLE PROTECTION AGAINST HARMFUL INTERFERENCE WHEN THE EQUIPMENT IS OPERATED IN A COMMERCIAL ENVIRONMENT. THIS EQUIPMENT GENERATES, USES, AND CAN RADIATE RADIO FREQUENCY ENERGY AND IF NOT INSTALLED AND USED IN ACCORDANCE WITH THE INSTRUCTION MANUAL, MAY CAUSE HARMFUL INTERFERENCE TO RADIO COMMUNICATIONS. OPERATION OF THIS EQUIPMENT IN A RESIDENTIAL AREA IS LIKELY TO CAUSE HARMFUL INTERFERENCE, IN WHICH CASE USERS WILL BE REQUIRED TO CORRECT THE INTERFERENCE AT THEIR OWN EXPENSE.

WARNING: CHANGES OR MODIFICATIONS NOT EXPRESSLY APPROVED BY THE PARTY RESPONSIBLE FOR COMPLIANCE COULD VOID THE USER'S AUTHORITY TO OPERATE THE EQUIPMENT.

THIS CLASS A DIGITAL APPARATUS COMPLIES WITH CANADIAN ICES-003.

CET APPAREIL NUMÉRIQUE DE LA CLASS A EST CONFORME À LA NORME NMB-003 DU CANADA.

The information in this manual is believed to be accurate as of the date of publication. ADEMCO Video is not responsible for any problems resulting from the use thereof. The information contained herein is subject to change without notice. Revisions or new editions to this publication may be issued to incorporate such changes.

Important Safeguards

1. Read Instructions

All the safety and operating instructions should be read before the appliance is operated.

2. Keep Instructions

The safety and operating instructions should be kept for future reference.

3. Cleaning

Unplug this equipment from the wall outlet before cleaning it. Do not use liquid aerosol cleaners. Use a damp soft cloth for cleaning.

4. Attachments

Never add any attachments and/or equipment without the approval of the manufacturer as such additions may result in the risk of fire, electric shock or other personal injury.

5. Water and/or Moisture

Do not use this equipment near water or in contact with water.

6. Accessories

Do not place this equipment on an unstable cart, stand or table. The equipment may fall, causing serious injury to a child or adult, and serious damage to the equipment. Wall or shelf mounting should follow the manufacturer's instructions, and should use a mounting kit approved by the manufacturer.



This equipment and cart combination should be moved with care. Quick stops, excessive force, and uneven surfaces may cause the equipment and cart combination to overturn.

7. Power Sources

This equipment should be operated only from the type of power source indicated on the marking label. If you are not sure of the type of power, please consult your equipment dealer or local power company.

8. Power Cords

Operator or installer must remove power and other connections before handling the equipment.

9. Lightning

For added protection for this equipment during a lightning storm, or when it is left unattended and unused for long periods of time, unplug it from the wall outlet and disconnect the antenna or cable system. This will prevent damage to the equipment due to lightning and power-line surges.

10. Overloading

Do not overload wall outlets and extension cords as this can result in the risk of fire or electric shock.

11. Objects and Liquids

Never push objects of any kind through openings of this equipment as they may touch dangerous voltage points or short out parts that could result in a fire or electric shock. Never spill liquid of any kind on the equipment.

12. Servicing

Do not attempt to service this equipment yourself. Refer all servicing to qualified service personnel.

13. Damage requiring Service

Unplug this equipment from the wall outlet and refer servicing to qualified service personnel under the following conditions:

- A. When the power-supply cord or the plug has been damaged.
- B. If liquid is spilled, or objects have fallen into the equipment.
- C. If the equipment has been exposed to rain or water.
- D. If the equipment does not operate normally by following the operating instructions, adjust only those controls that are covered by the operating instructions as an improper adjustment of other controls may result in damage and will often require extensive work by a qualified technician to restore the equipment to its normal operation.
- E. If the equipment has been dropped, or the cabinet damaged.
- F. When the equipment exhibits a distinct change in performance — this indicates a need for service.

14. Replacement Parts

When replacement parts are required, be sure the service technician has used replacement parts specified by the manufacturer or that have the same characteristics as the original part. Unauthorized substitutions may result in fire, electric shock or other hazards.

15. Safety Check

Upon completion of any service or repairs to this equipment, ask the service technician to perform safety checks to determine that the equipment is in proper operating condition.

16. Field Installation

This installation should be made by a qualified service person and should conform to all local codes.

17. Correct Batteries

Warning: Risk of explosion if battery is replaced by an incorrect type. Dispose of used batteries according to the instructions.

18. Ambient Temperature (Tmra)

A manufacturer's maximum recommended ambient temperature (Tmra) for the equipment must be specified so that the customer and installer may determine a suitable maximum operating environment for the equipment.

19. Elevated Operating Ambient Temperature

If installed in a closed or multi-unit rack assembly, the operating ambient temperature of the rack environment may be greater than room ambient. Therefore, consideration should be given to installing the equipment in an environment compatible with the manufacturer's maximum rated ambient temperature (Tmra).

20. Reduced Air Flow

Installation of the equipment in the rack should be such that the amount of airflow required for safe operation of the equipment is not compromised.

21. Mechanical Loading

Mounting of the equipment in the rack should be such that a hazardous condition is not caused by uneven mechanical loading.

22. Circuit Overloading

Consideration should be given to connection of the equipment to supply circuit and the effect that overloading of circuits might have on over current protection and supply wiring. Appropriate consideration of equipment nameplate ratings should be used when addressing this concern.

23. Reliable Earthing (Grounding)

Reliable grounding of rack mounted equipment should be maintained. Particular attention should be given to supply connections other than direct connections to the branch circuit (e.g., use of power strips).

Table of Contents

- Chapter 1 — Introduction 1
 - Features 1
 - Technical Overview 2

- Chapter 2 — Installation..... 3
 - Package Contents 3
 - Required Installation Tools 3
 - Setting Unit for NTSC or PAL 4
 - Connecting the Video Source 4
 - Connecting the Loop Through Video 4
 - Connecting the Monitor 5
 - Connecting Audio 5
 - Connecting Alarms 5
 - AI 1 to 16 (Alarm In) 6
 - GND (Ground) 6
 - AO 1 TO 4 (Alarm Out) 6
 - ARI (Alarm Reset In) 6
 - Connecting to the RS485..... 7
 - Connecting to the Network Port..... 7
 - Connecting to the USB Port..... 7
 - Connecting the Printer 8
 - Connecting to the RS232 Port..... 8
 - Factory Reset 9
 - Connecting the Power Cord..... 9

- Chapter 3 — Configuration..... 11
 - Front Panel Controls..... 11
 - POWER Button 11
 - Up, Down, Left, Right Arrow Buttons..... 11
 - Enter Button 11
 - ALARM Button 12
 - MENU Button 12
 - PTZ Button 12
 - Camera Buttons (1 to 16)..... 12
 - DISPLAY Button..... 12
 - SEQUENCE Button..... 12
 - FREEZE Button..... 12
 - COUNTER Button 12
 - SEARCH Button..... 13
 - PLAY/PAUSE Button 13

RW (Rewind) Button	13
FF (Fast Forward) Button.....	13
STOP Button.....	13
REC (Record) Button.....	13
Shuttle Ring	14
Jog Dial.....	14
Turning on the Power	14
Review of Front Panel Display.....	14
Initial Unit Setup	15
Password.....	15
Quick Setup Screen.....	16
Normal Setup Screen	17
System Information	18
Date/Time Setup.....	20
System Log Screen.....	22
System Check Screen.....	22
Configuring Input Devices.....	24
Camera Setup Screen.....	24
Alarm In Setup Screen.....	26
Motion Detector.....	26
Alarm Out Setup Screen	28
Audio Setup Screen	30
RS232/RS485 Setup Screen	31
Configuring Recording Settings.....	32
Record Mode Setup Screen.....	32
Time-Lapse Record Mode Setup Screen.....	33
Time-Lapse Recording Schedule.....	34
Pre-Event Recording Setup Screen.....	35
Event Action Setup.....	36
Alarm In Event Action (Record) Setup Screen.....	36
Alarm In Event Action (Alarm Out) Setup Screen	37
Alarm In Event Action (Notify) Setup Screen	38
Motion Detector Event Action (Record) Setup Screen	39
Motion Detector Event Action (Alarm Out) Setup Screen.....	40
Motion Detector Event Action (Notify) Setup Screen	41
Video Loss Event Action (Record) Setup Screen.....	42
Video Loss Event Action (Alarm Out) Setup Screen.....	43
Video Loss Event Action (Notify) Setup Screen.....	44
OSD (On-Screen Display) Setup.....	45
Sequence Display Setup Screen.....	46
Network Setup Screen.....	47
LAN Setup Screen	48

Modem Setup.....	49
Callback Center (LAN) Setup Screen.....	50
Callback Center (Modem) Setup Screen.....	51
Password Setup Screen	52
Config Screen.....	53
Backup.....	54
Load Default Setup	54
Clear All Data.....	54
Chapter 4 — Operation	55
Turning on the Power	55
Live Monitoring	55
PIP Mode	56
PTZ Mode	56
Recording Video	57
Recording Audio	57
Playing Recorded Video	58
RW (Rewind) Button	58
FF (Fast Forward) Button.....	58
STOP Button.....	58
Camera Buttons (1 to 16).....	58
DISPLAY Button.....	58
Shuttle Ring.....	59
Jog Dial	59
Searching Video	59
Date/Time Search	60
Calendar Search	60
Event Search.....	61
Printing	63
Archiving.....	63
Appendix A — USB Hard Disk Drive Preparation.....	65
Preparing the USB-IDE hard disk drive in Windows2000	65
Preparing USB-IDE hard disk drive in Windows 98.....	65
Appendix B — Reviewing Backup Images	67
Appendix C — Troubleshooting.....	69
Appendix D — Connector Pin Outs	70
I/O Connector Pin Outs.....	70
RS485 Connector Pin Outs	70

RS232 Connector Pin Outs	71
Appendix E — Map of Screens	72
Appendix F – External Protocols	73
Message Format.....	73
Control Flow	73
Common Reply.....	73
Op Code	74
Error code.....	74
AHDR4	75
AHDR9	76
AHDR16	77
Appendix G — Specifications.....	78

List of Illustrations

Figure 1 — Typical DVR installation.....	1
Figure 2 — 16-Channel DVR rear panel. (Others are similar.)	3
Figure 3 — NTSC/PAL switch.....	4
Figure 4 — Video input connectors.....	4
Figure 5 — Video Loop Through connectors.....	4
Figure 6 — Video Out connectors.....	5
Figure 7 — Audio In and Out connectors.....	5
Figure 8 — Alarm Input connector strips.....	5
Figure 9 — Alarm Output connector strips.....	6
Figure 10 — RS485 Connector.....	7
Figure 11 — Network connector.....	7
Figure 12 — USB connector.....	7
Figure 13 — Printer connector.....	8
Figure 14 — RS232 connector.....	8
Figure 15 — Factory reset switch.....	9
Figure 16 — Power cord connector.....	9
Figure 17 — 16-Channel DVR front panel. (Others are similar.).....	11
Figure 18 — Front panel display.....	14
Figure 19 — Admin Password screen.....	15
Figure 20 — Quick Setup screen.....	16
Figure 21 — Normal Setup screen.....	17
Figure 22 — System Information screen.....	18
Figure 23 — System Information Change screen.....	18
Figure 24 — Language dropdown menu.....	19
Figure 25 — Virtual keyboard.....	19
Figure 26 — Date/Time setup screen.....	20
Figure 27 — Holiday Setup screen.....	21
Figure 28 — System Log screen.....	22
Figure 29 — System Check screen.....	23
Figure 30 — Device menu screen.....	24
Figure 31 — Camera setup screen.....	24
Figure 32 — PTZ Device list.....	25
Figure 33 — Alarm In setup screen.....	26
Figure 34 — Motion Detector setup screen.....	26
Figure 35 — Motion Detection Zone screen.....	27
Figure 36 — Alarm Out setup screen.....	28
Figure 37 — Alarm Out Schedule screen.....	29
Figure 38 — Audio Setup screen.....	30
Figure 39 — RS232/RS485 setup screen.....	31
Figure 40 — Record Mode Setup screen.....	32
Figure 41 — Time-Lapse Record Setup screen.....	33
Figure 42 — Time-Lapse Recording Schedule screen.....	34
Figure 43 — Pre-Event Record Setup screen.....	35
Figure 44 — Alarm In Event Action (Record) setup screen.....	36
Figure 45 — Alarm In Event Action (Alarm Out) setup screen.....	37
Figure 46 — Alarm In Event Action (Notify) setup screen.....	38
Figure 47 — Motion Detector Event Action (Record) setup screen.....	39
Figure 48 — Motion Detector Event Action (Alarm Out) setup screen.....	40

Figure 49 — Motion Detector Event Action (Notify) setup screen.....	41
Figure 50 — Video Loss Event Action (Record) setup screen.....	42
Figure 51 — Video Loss Event Action (Alarm Out) setup screen.....	43
Figure 52 — Video Loss Event Action (Notify) setup screen.....	44
Figure 53 — OSD Setup screen.....	45
Figure 54 — Sequence Display setup screen.....	46
Figure 55 — Network Setup screen.....	47
Figure 56 — LAN Setup screen.....	48
Figure 57 — RS232/RS485 setup screen.....	49
Figure 58 — Callback Center (LAN) Setup screen.....	50
Figure 59 — Callback Center (Modem) Setup screen.....	51
Figure 60 — Password setup screen.....	52
Figure 61 — Config screen.....	53
Figure 62 — Backup screen.....	54
Figure 63 — PTZ Preset screen.....	56
Figure 64 — Preset view screen.....	56
Figure 65 — Search Menu.....	59
Figure 66 — Date/Time Search screen.....	60
Figure 67 — Calendar Search screen.....	60
Figure 68 — Event Log screen.....	61
Figure 69 — Event Search (by Camera) screen.....	62
Figure 70 — Event Search (by Event) screen.....	62
Figure 71 — Print screen.....	63
Figure 72 — Backup screen.....	63
Figure 73 — Player screen.....	67

Chapter 1 — Introduction

Features

Your color digital video recorder (DVR) provides recording capabilities for four, nine or 16 camera inputs. It provides exceptional picture quality in both live and playback modes, and offers the following features:

- 4, 9 or 16 Composite Input Connectors
- Compatible with Color (NTSC or PAL) and B&W (CCIR and EIA-170) Video Sources
- Multiple Search Engines (Date/Time, Calendar, Event)
- Records up to 60 NTSC Images per Second (50 PAL Images per Second)
- “Loop-Through” Video Connectors
- Continuous Recording in Disk Overwrite Mode
- Front Panel Displays Time, Date, Recording Mode and Remaining Storage Capacity and More
- Video Archiving via USB Interface
- Continues Recording while Archiving, Transmitting to Remote Site and during Playback
- User-friendly Graphical User Interface (GUI) Menu System in Multiple Languages
- Two Record Modes (Time and Event)
- Audio Recording and Playback
- Alarm Connections Include: Input, Output and Reset Input
- Built-in Alarm Buzzer
- Live or Recorded Video Access via Ethernet or External Modem (network model only)

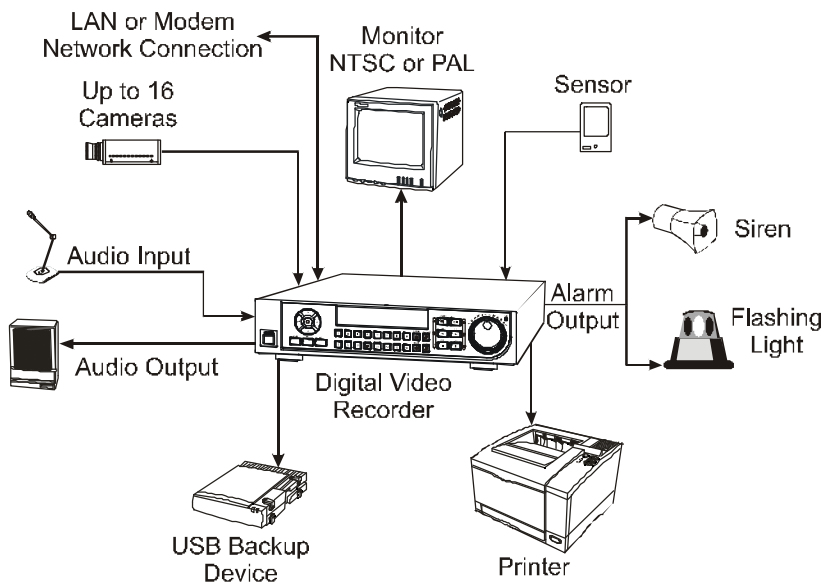

Figure 1 — Typical DVR installation.

Technical Overview

Your DVR can replace both a time-lapse VCR and a multiplexer in a security installation. However, it has many features that make it much more powerful and easier to use than even the most advanced VCR.

The DVR converts analog NTSC or PAL video to digital images and records them on a hard disk drive. Using a hard disk drive allows you to access recorded video almost instantaneously; there is no need to rewind tape. The technology also allows you to view recorded video while the DVR continues recording video.

Digitally recorded video has several advantages over analog video recorded on tape. There is no need to adjust tracking. You can freeze frames, fast forward, fast reverse, slow forward and slow reverse without image streaking or tearing. Digital video can be indexed by time or events, and you can instantly view video after selecting the time or event.

Your DVR can be set up for event or time-lapse recording. You can define times to record, and the schedule can change for different days of the week and user defined holidays.

The DVR can be set up to alert you when the hard disk drive is full, or it can be set up to record over the oldest video once the disk is full.

Your DVR uses a proprietary encryption scheme making it nearly impossible to alter video.

You can view video and control your DVR remotely by connecting via modem or Ethernet. A standard PostScript™ computer printer can be connected to the DVR to print frame captures. There is a USB port that can be used to archive video to external hard disk drives. (Network model only.)

NOTE: This manual covers the 4-, 9- 16-channel digital video recorders. The DVRs are identical except for the number of cameras and alarms that can be connected and the number of cameras that can be displayed. For simplicity, the illustrations and descriptions in this manual refer to the 16-camera model.

There are several versions of each model. If the model number includes an “E,” the DVR does not have network features. The numbers after the hyphen indicate the storage capacity. For example, an AHDR9E-160 is a 9-channel unit that has 160GB of storage capacity and does not have network features. The following units are available:

System Series (Networkable)

4 Channel	9 Channel	16 Channel
AHDR4-80	AHDR9-80	AHDR16-80
AHDR4-160	AHDR9-160	AHDR16-160
AHDR4-320	AHDR9-320	AHDR16-320

E Series (No Network Features)

4 Channel	9 Channel	16 Channel
AHDR4E-80	AHDR9E-80	AHDR16E-80
AHDR4E-160	AHDR9E-160	AHDR16E-160
AHDR4E-320	AHDR9E-320	AHDR16E-320

Chapter 2 — Installation

Package Contents

The package contains the following:

- Digital Video Recorder
- Power Cord
- User’s Manual (This Document)
- Multilingual User’s Manual (CD-ROM)
- RAS User’s Manual (Not with E Series)
- Multilingual RAS Software and User’s Manual (CD-ROM, Not with E Series)
- Rack-mount Kit
- Assembly Screws for Adding Hard Disk Drives

Required Installation Tools

No special tools are required to install the DVR. Refer to the installation manuals for the other items that make up part of your system.

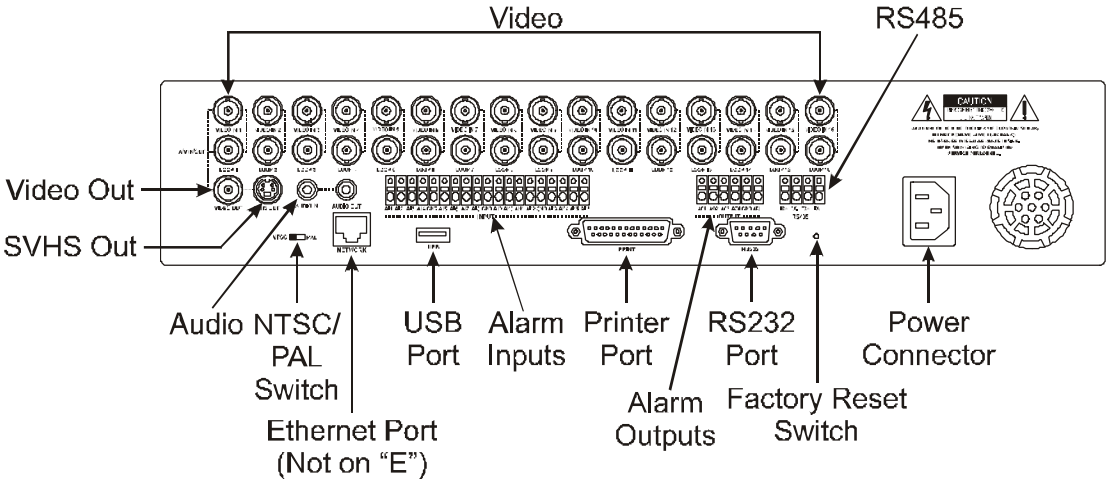

Figure 2 — 16-Channel DVR rear panel. (Others are similar.)

Setting Unit for NTSC or PAL



Figure 3 — NTSC/PAL switch.

Your DVR can be used with either NTSC or PAL equipment. Before turning on the DVR, set the switch to NTSC or PAL to match your equipment.

NOTE: You cannot mix NTSC and PAL equipment. For example you cannot use a PAL camera and an NTSC monitor.

CAUTION: If you set the switch from NTSC (PAL) to PAL (NTSC), please do the *Factory Reset* and *Clear All Data*. If not, it causes the DVR to perform wrong operations.

Connecting the Video Source



Figure 4 — Video input connectors.

Connect the coaxial cables from the video sources to the BNC Video In connectors.

Connecting the Loop Through Video

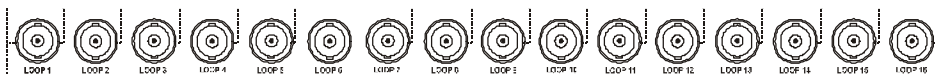

Figure 5 — Video Loop Through connectors.

If you would like to connect your video source to another device, you can use the Loop BNC connectors.

NOTE: The Loop BNC connectors are auto terminated. Do NOT connect a cable to the Loop BNC unless it is connected to another terminated device because it will cause poor quality video.

Connecting the Monitor

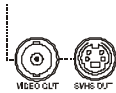

Figure 6 — Video Out connectors.

Connect the monitor to either the Video Out or SVHS Out connector.

NOTE: If your monitor has an SVHS input, use it because it will give you better quality video display.

NOTE: The *Video Out* (BNC) and the *SVHS Out* connectors may be connected to individual monitors for simultaneous operation.

Connecting Audio

NOTE: It is the user's responsibility to determine if local laws and regulations permit recording audio.

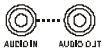

Figure 7 — Audio In and Out connectors.

Your DVR can record audio. Connect the audio source to Audio In. Connect Audio Out to your amplifier.

NOTE: The DVR does not have amplified audio output, so you will need a speaker with an amplifier. The audio input can be from an amplified source or directly from a microphone.

Connecting Alarms

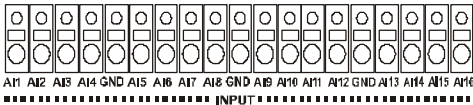

Figure 8 — Alarm Input connector strips.

NOTE: To make connections on the Alarm Connector Strip, press and hold the button and insert the wire in the hole below the button. After releasing the button, tug gently on the wire to make certain it is connected. To disconnect a wire, press and hold the button above the wire and pull out the wire.

AI 1 to 16 (Alarm In)

You can use external devices to signal the DVR to react to events. Mechanical or electrical switches can be wired to the AI (Alarm In) and GND (Ground) connectors. The threshold voltage is 4.3V and should be stable at least 0.5 seconds to be detected. See *Chapter 3 — Configuration* for configuring alarm input.

GND (Ground)

NOTE: All the connectors marked GND are common.

Connect the ground side of the Alarm input and/or alarm output to the GND connector.

AO 1 TO 4 (Alarm Out)

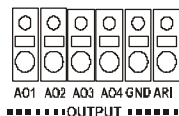

Figure 9 — Alarm Output connector strips.

The DVR can activate external devices such as buzzers or lights. Connect the device to the AO (Alarm Out) and GND (Ground) connectors. AO is an active low open collector output which sinks 5mA@12V and 30 mA@5V. See *Chapter 3 — Configuration* for configuring alarm output.

ARI (Alarm Reset In)

An external signal to the Alarm Reset In can be used to reset both the Alarm Out signal and the DVR's internal buzzer. Mechanical or electrical switches can be wired to the AI (Alarm In) and GND (Ground) connectors. The threshold voltage is 4.3V and should be stable at least 0.5 seconds to be detected. Connect the wires to the ARI (Alarm Reset In) and GND (Ground) connectors.

Connecting to the RS485

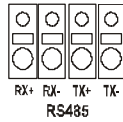

Figure 10 — RS485 Connector.

The DVR can be controlled remotely by an external device or control system, such as a control keyboard, using RS485 half-duplex serial communications signals. The RS485 connector can also be used to control PTZ (pan, tilt, zoom) cameras. Connect RX+, RX-, TX+ and TX- of the control system to the TX+, TX-, RX+ and RX- (respectively) of the DVR. See *Chapter 3 — Configuration* and the PTZ camera manufacturer's manual for configuring the RS485 connection.

Connecting to the Network Port

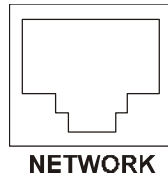

Figure 11 — Network connector.

The DVR can be networked using the 10/100Mb Ethernet connector (Networkable Model Only). Connect a Cat5 cable with an RJ-45 jack to the DVR connector. The DVR can be networked with a computer for remote monitoring, searching, configuration and software upgrades. See *Chapter 3 — Configuration* for configuring the Ethernet connections.

Connecting to the USB Port



Figure 12 — USB connector.

A USB port is provided to connect external hard disk drives for archiving video. Position the external hard disk drive close enough to the DVR so that you can make the cable connections, usually less than 6 feet. Use the USB cable provided with the hard disk drive to connect it to the DVR. See *Chapter 4 — Operation* for information on archiving video to an external USB hard disk drive.

Connecting the Printer

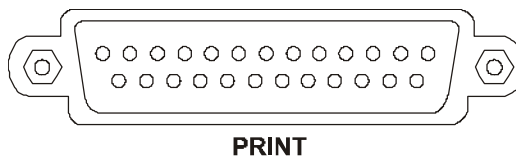

Figure 13 — Printer connector.

You can print images from your DVR on PostScript™ printers. The DVR supports PostScript™ 2.0 and higher. If you have a color PostScript™ printer, you can print color images. Place the printer on a sturdy surface near enough to the DVR so that you will be able to make the cable connections. Connect the DB-25P end of the cable to the DB-25S Printer connector on the back of the DVR. Connect the other end of the cable to the printer. See *Chapter 4 — Operation* for information on printing images.

NOTE: Only PostScript™ printers will work with the DVR.

NOTE: The DVR is not supplied with a printer cable, and many printers are not supplied with cables. Make certain you have the correct cable when purchasing the printer.

Connecting to the RS232 Port

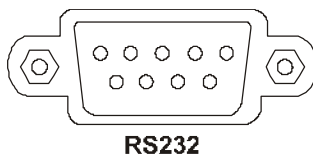

Figure 14 — RS232 connector.

An RS232 port is provided to connect an external modem for remote monitoring, configuration and software upgrades. Use a modem cable with a DB-9S (female) connector to connect to the DVR. See *Chapter 3 — Configuration* for configuring the modem.

NOTE: The DVR is not supplied with a modem cable, and many modems are not supplied with cables. Make certain you have the correct cable when purchasing the modem.

Factory Reset

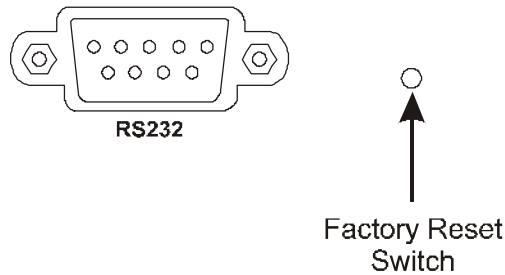

Figure 15 — Factory reset switch.

The DVR has a **Factory Reset** switch to the right of the RS232 connector. This switch will only be used on the rare occasions that you want to return all the settings to the original factory settings.

CAUTION: When using the *Factory Reset*, you will lose any setting you have made.

To reset the unit, you will need a straightened paperclip:

1. Turn the DVR off.
2. Turn it on again.
3. While the DVR is initializing, poke the straightened paperclip in the unlabeled hole to the right of the RS232 connector.
4. Hold the switch until all the LEDs and all the segments on the Front Panel Display are lit.

NOTE: When the DVR successfully resets to factory defaults all the LEDs and the segments on the Front Panel Display flash three times.

5. Release the reset switch. All of the DVR's settings are now at the original settings it had when it left the factory.

Connecting the Power Cord

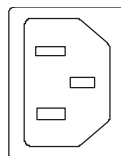

Figure 16 — Power cord connector.

Connect the power cord to the DVR and then to the wall outlet.

WARNING: ROUTE POWER CORDS SO THAT THEY ARE NOT A TRIPPING HAZARD. MAKE CERTAIN THE POWER CORD WILL NOT BE PINCHED OR ABRADED BY FURNITURE. DO NOT INSTALL POWER CORDS UNDER RUGS OR CARPET. THE POWER CORD HAS A GROUNDING PIN. IF YOUR POWER OUTLET DOES NOT HAVE A GROUNDING PIN RECEPTACLE, DO NOT MODIFY THE PLUG. DO NOT OVERLOAD THE CIRCUIT BY PLUGGING TOO MANY DEVICES IN TO ONE CIRCUIT.

Your DVR is now ready to operate. Refer to *Chapter 3 — Configuration* and *Chapter 4 — Operation*.

Chapter 3 — Configuration

NOTE: Your DVR should be completely installed before proceeding. Refer to *Chapter 2 — Installation*.

Front Panel Controls

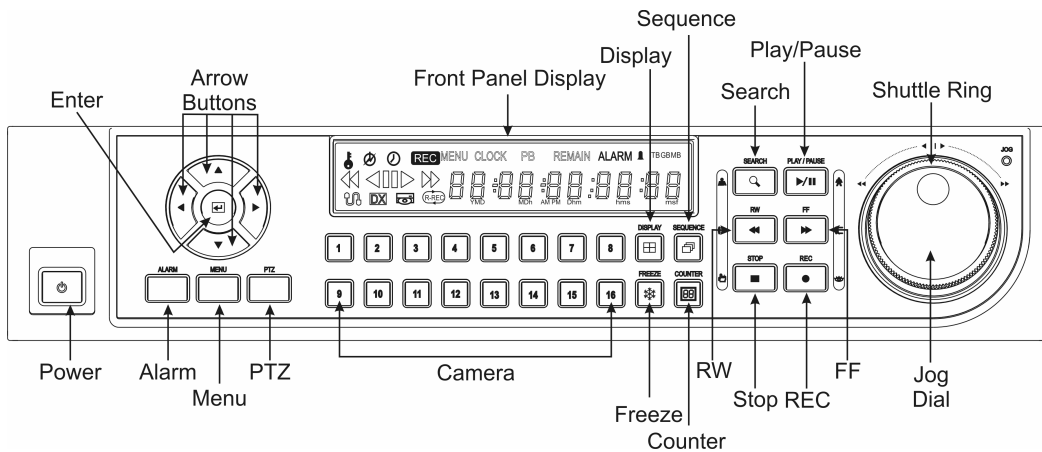

Figure 17 — 16-Channel DVR front panel. (Others are similar.)

The front panel looks and operates much like a VCR combined with a multiplexer. Many of the buttons have multiple functions. The following describes each button and control. Take a few minutes to review the descriptions. You will use these to initially set up your DVR and for daily operations.

POWER Button

The **POWER** button turns the unit on and off. When turning off the DVR, you need to confirm that you want to turn off the unit, and you will be asked for an administrator password.

Up, Down, Left, Right Arrow Buttons

These buttons are used to navigate through menus and GUI. They are also used to control Pan and Tilt when in the PTZ mode. The arrow buttons can be used to move the position of the active cameo screen, and also move through screen pages.

Enter Button

The **Enter** button selects a highlighted item or completes an entry that you have made.

ALARM Button

The **ALARM** button has two functions. First, it will reset the DVR's outputs including the internal buzzer during an alarm. Second, it will display the event log when you are in the live monitoring mode unless there is an active alarm. This operation can be user password protected.

MENU Button

Pressing the **MENU** button enters the Quick Setup screen. You will need to enter the administrator password to access the Quick Setup. Pressing the button also closes the current menu or setup dialog box.

PTZ Button

Pressing the **PTZ** button opens a Pan/Tilt/Zoom screen, which allows you to control properly configured cameras.

Camera Buttons (1 to 16)

Pressing the individual camera buttons will cause the selected camera to display full screen. They are also used to enter passwords.

DISPLAY Button

Pressing the **DISPLAY** button toggles between different display formats. The available formats are: full, 4x4, 3x3, 2x2 and PIP.

SEQUENCE Button

When in the live mode, pressing the **SEQUENCE** button displays another full live channel sequentially. When in one of the multi-view formats, pressing this button will cause the DVR to sequence cameras in two sequence modes: "Page" and "Cameo". In the Page mode, the DVR sequences through user-defined screen layouts (pages). In the Cameo mode, the bottom, right screen to display live cameras sequentially. Pressing the **SEQUENCE** button while in the Sequence mode will exit the Sequence mode.

FREEZE Button

Pressing the **FREEZE** button freezes the current live screen.

COUNTER Button

Pressing the **COUNTER** button switches between displaying the time and the remaining storage capacity on the front panel display.

SEARCH Button

Pressing the **SEARCH** button displays the Search menu. Pressing the button again will exit the Search menu. This operation can be user password protected. Zooms In in PTZ mode.

PLAY/PAUSE Button

Pressing the **PLAY/PAUSE** button plays back images at regular speed. Pressing the button while in the playback mode will pause the video. The screen displays ► when the DVR is playing back video. The screen displays || when in the Pause mode. Zooms Out in PTZ mode.

Entering Playback mode from Live Monitoring mode can be user password protected.

RW (Rewind) Button

Pressing the **RW** button plays video backward at high speed. Pressing the button again toggles the playback speed from ◀◀, ◀◀◀ and ◀◀◀◀. The screen displays ◀◀, ◀◀◀ and ◀◀◀◀ respectively. Used for near Focus in the PTZ mode.

Entering Fast Backward Playback mode from Live Monitoring mode can be password protected.

FF (Fast Forward) Button

Pressing the **FF** button plays video forward at high speed. Pressing the button again toggles the playback speed from ▶▶, ▶▶▶ and ▶▶▶▶. The screen displays ▶▶, ▶▶▶ and ▶▶▶▶ respectively. Used for far Focus in PTZ mode.

Entering Fast Playback mode from Live Monitoring mode can be password protected.

STOP Button

Pressing the **STOP** button during Playback mode returns the DVR to the Live Monitoring mode. Saves Presets in PTZ mode.

REC (Record) Button

Press the **REC** button to set the DVR so that it is ready to record video. A red dot appears on the screen and REC appears on the Front Panel Display when the DVR is recording video. Press the button again to stop recording video. This operation can be user password protected. Loads a Preset View in PTZ mode.

Shuttle Ring

The Shuttle Ring only functions in the Playback mode. The Shuttle Ring is spring loaded and returns to the center position when released. Turning the ring clockwise plays video forward. Turning the ring counterclockwise plays video backward. Playback speed varies with the amount the ring is turned. The playback speeds are ◀x0.5, ◀◀, ◀◀◀, ◀◀◀◀, ▶x0.5, ▶, ▶▶, ▶▶▶ and ▶▶▶▶.

When you release the ring, it snaps back to the center position and the video pauses.

Jog Dial

The Jog Dial only functions when playback video has been paused. By turning the jog dial clockwise, you can play video forward image-by-image. By turning the jog dial counterclockwise, you play video backward image-by-image.

Turning on the Power

Press the **POWER** button to turn on the DVR. The unit will take approximately 60 seconds to initialize. While it is initializing, the DVR will display HELLO. Then, the HELLO will start moving to the left.

The **POWER** button can also be used to turn off the power once the DVR has completed its initialization process. However, this is a protected feature requiring an administrator password.

Review of Front Panel Display

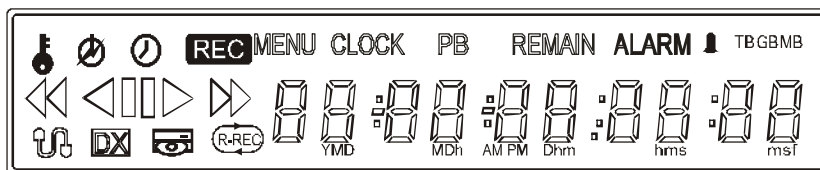

Figure 18 — Front panel display.

- 🔑 The key icon displays when the unit is in the Key Lock mode.
- ⊘ The circle with the broken line displays whenever the system was not properly shut down such as a power failure.
- 🕒 The clock icon displays when any camera is in the time-lapse mode.
- REC** REC displays while the unit is recording.
- MENU** MENU displays when the DVR is in Menu mode.

CLOCK CLOCK displays when the digits are displaying the current time.

PB PB displays when video is being played back and the digits are displaying the time of the recording.

REMAIN REMAIN displays when the digits are displaying the remaining hard disk drive capacity.

ALARM ALARM displays when any camera is in the event-driven recording mode.

 The bell icon displays during alarm activation.

TBGBMB These light when the display is in the remaining disk capacity mode. TB = TeraBytes, GB = GigaBytes and MB = MegaBytes.

 This icon displays when video is being played backward at fast speed.

 This icon displays when video is being played backward at regular speed.

 This icon displays when video is paused.

 This icon displays when video is being played forward at regular speed.

 This icon displays when video is being played forward at fast speed.

 The network icon displays when the unit is networked either via Ethernet or modem.

 DX displays when the DVR is operating in the Duplex mode.

 The disk icon displays when data is being backed up using the USB port.

 R-REC displays when the DVR is in the Repeat Record mode. The DVR will continue recording when the hard disk drive is full by recording over the oldest video.

 The digits display Time, Date and Remaining Capacity.

Initial Unit Setup

Before using your DVR for the first time, you will want to establish the initial settings. This includes items such as time and date, display language, camera, audio, remote control, record mode, network and password. Your DVR can be set up using various screens and dialog boxes.

Password

Press the **MENU** button to enter the setup screens. The Admin Password screen appears.

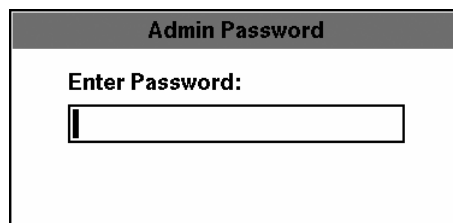

Figure 19 — Admin Password screen.

Enter the password by pressing the appropriate combination of Camera number buttons and then the Enter button. The factory default password is 4321. There are two Setup screens: Quick Setup and Normal Setup. The factory default is the Quick Setup screen.

Quick Setup Screen

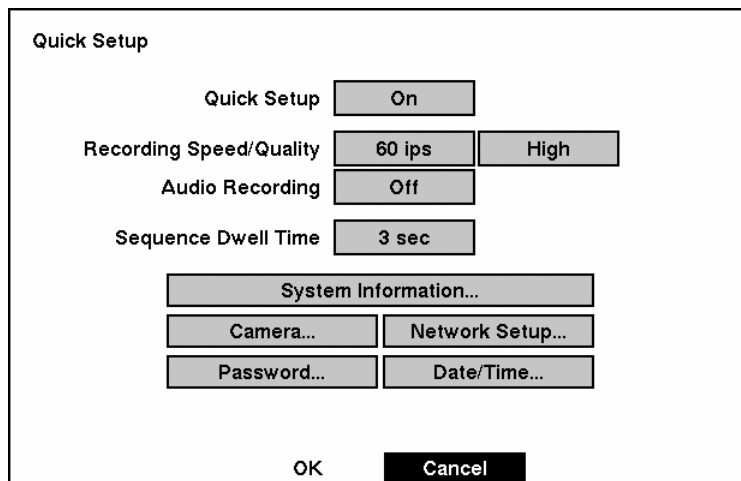



Figure 20 — Quick Setup screen.

The Quick Setup screen allows you to set up the most commonly used features of your DVR. Use the arrow buttons to move through the options. Pressing the  button lets you make your selections.

Highlight the box beside Quick Setup and press the  button to toggle between On and Off. If you select Off, you will use the Normal Setup screen to change the DVR's settings.

Highlight the Record Speed box and select recording speeds from as few as one image every 10 seconds to as fast as 60 ips.

Highlight the Record Quality box and select from Very High, High, Standard and Low.

Highlight the box beside Audio Recording and select either On or Off.

NOTE: It is the user's responsibility to determine if local laws and regulations permit recording audio.

Highlight the box beside Sequence Dwell Time and select from 3 to 60 seconds for the camera sequence dwell time.

Selecting **System Information...** enters that screen.

Selecting **Camera...** enters a screen where you can set up camera information.

Selecting **Network Setup...** enters a screen where you can set up network information.

Selecting **Password...** enters a screen where you will be able to change passwords.

Selecting **Date/Time...** enters a screen where you will be able to set the DVR's time and date.

Normal Setup Screen

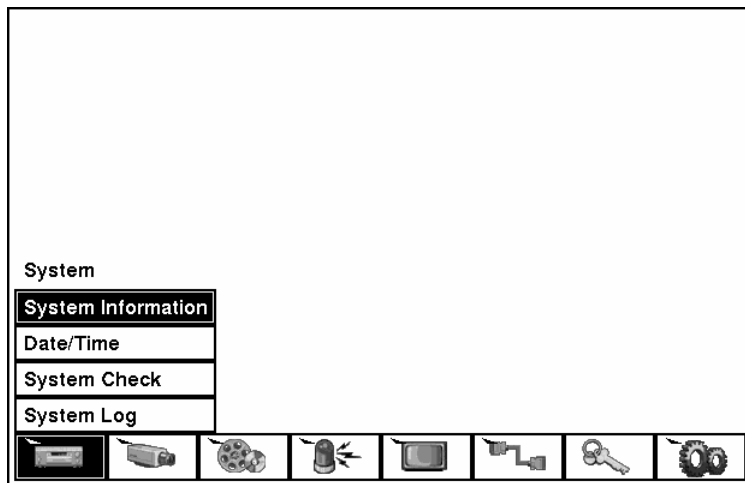

Figure 21 — Normal Setup screen.

Press the **MENU** button to enter the setup screen. If the **Quick Setup** screen appears, turn it off as described above. The **Normal Setup** screen gives you access to all the DVR's setup screens.

System Information

Highlight **System Information** and press the **↵** button. The **System Information** screen appears. The number after the model indicates the hardware and software versions. In the example below, the hardware version is 2.0, and the software version is 0.500.

The screenshot shows the 'System Information - ADR1600 2.0.0.500' screen. It contains the following fields and values:

Site Description	[Empty text box]
Unit ID	0
Language	English
Disk Usage	10.8 GB remains / 39.9GB total
Recorded From	2001-11-06 21:03:05
To	2001-11-12 13:25:51

At the bottom right is a **Change** button, and at the bottom center is a **Close** button.

Figure 22 — System Information screen.

In the **System Information** screen, you can name the site location, assign a unit ID number and select the language the screens are displayed in. Highlight **Change** and press the **↵** button. The **System Information Change** screen appears.

The screenshot shows the 'System Information Change' screen. It contains the following fields and values:

Site Description	[Empty text box]
Unit ID	0
Language	English

At the bottom left is an **OK** button, and at the bottom right is a **Cancel** button.

Figure 23 — System Information Change screen.

Highlight the box beside Unit ID and press the button. Change the number by highlighting it and using the Up and Down arrow buttons to increase and decrease the number. The Unit ID number is used to identify the unit when it is networked with other DVRs. You cannot use the same number for two or more DVRs that are within the same network.

Highlight the box beside Language and press button. A dropdown menu displays the available languages. Highlight the desired language and press the button.

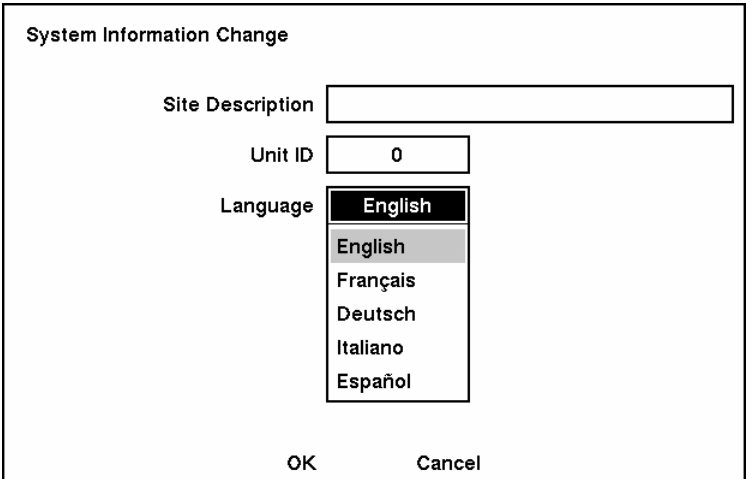

Figure 24 — Language dropdown menu.

Highlight the box beside Site Description and press the button. A virtual keyboard displays.

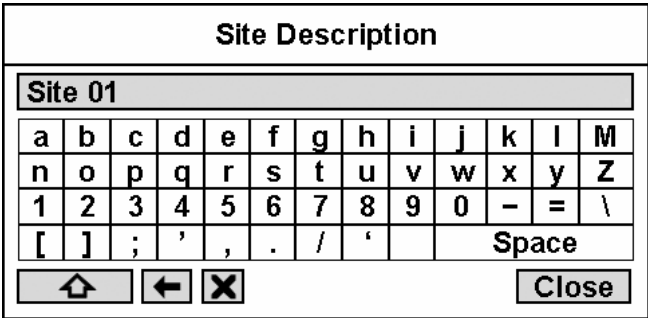

Figure 25 — Virtual keyboard.

Use the arrow keys to highlight the first character you want in the Site Title and press the button. That character appears in the title bar and the cursor moves to the next position. Pressing toggles between the upper and lower case keyboards, backspaces, and deletes entered characters. You can use up to 20 characters including spaces in your title.

Once you have entered your title, highlight **Close** and press the button.

Highlight the box beside **Unit ID** and press the button. Change the number by highlighting it and using the **Up** and **Down** arrow buttons to increase and decrease the number.

After you have created a title, assigned a unit ID number and selected a language, you can save your changes by highlighting **OK** and pressing the button. Selecting **Cancel** exits the screen without saving the changes.

Date/Time Setup

Highlight **Date/Time** in the Main Menu and press the button. The **Date/Time** setup screen appears.

Date/Time	
Date/Time	01-21-2002 06:44:34 AM
Time Zone	GMT-05:00 Eastern Time (US & Cana)
Daylight Saving Time	Off
Holiday Setup...	
Date Format	MM-DD-YYYY
Time Format	12 Hours (AM/PM)
OK Cancel	

Figure 26 — Date/Time setup screen.

CAUTION: If you set a date and time that is older than some of your recorded images, any images with dates and times later than the new setting will be deleted.

Highlight the first box beside **Date/Time** and press the button. The individual sections of the date highlight. Use the **Up** and **Down** arrow buttons to change the number. Use the **Left** and **Right** arrow buttons to move between month, date and year. Once you have the correct date, press the button.

NOTE: The clock will not start running until you have restarted the unit, so you may wish to set the time last.

Highlight the box beside **Time Zone** and press the button. Select the time zone you are in from the list and press the button.

Highlight the box beside Daylight Saving Time and press the button. Pressing the button toggles between On and Off.

Highlight the Holiday Setup... box and press the button. You can set up holidays by highlighting Add: and pressing the button. The current date appears.

Highlight the month and day and change them by using the Up and Down arrow buttons. Press the button to add the date. Dates can be deleted by highlighting the X beside the date and pressing the button.

NOTE: Holidays that do not fall on the same date each year should be updated once the current year's holiday has passed.

No.	Date	
1	07-04-yyyy	<input checked="" type="checkbox"/>
2	12-25-yyyy	<input type="checkbox"/>
		<input type="checkbox"/>
		<input type="checkbox"/>
		<input type="checkbox"/>
		<input type="checkbox"/>

2 ▲ ▼ Add...
 OK Cancel

Figure 27 — Holiday Setup screen.

You can save your changes by highlighting OK and pressing the button. Selecting Cancel exits the screen without saving the changes.

Highlight the box beside Date Format and press the button. A list of date formats appears. Highlight the format you wish to use and press the button. The choices are:

MM-DD-YYYY
 DD-MM-YYYY
 YYYY-MM-DD
 MM/DD/YYYY
 DD/MM/YYYY
 YYYY/MM/DD



To change the time format, highlight the box beside Time Format and press the button. The DVR toggles between 12 Hours (AM/PM) and 24 Hours (military time).

You can save your changes by highlighting OK and pressing the  button. Selecting Cancel exits the screen without saving the changes.

System Log Screen

Highlight System Log in the Main menu and press the  button. The System Log screen appears.

System Log		
No.	Event	Date/Time
1283	Setup Begin (Local)	2002-01-24 10:27:14
1282	System Started	2002-01-24 10:27:12
1281	Shutdown	2002-01-24 10:27:02
1280	System Time Changed	2002-01-24 10:27:00
1279	Setup Begin (Local)	2002-01-24 10:26:08
1278	System Started	2002-01-24 10:26:02
1277	Recovered from Power Failure	2002-01-24 10:26:02

1283  

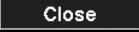





Figure 28 — System Log screen.

The System Log screen displays a record of various events logged by the DVR. The list shows the dates and times the system was turned ON and OFF, power failed, recording was started or stopped, playback was started or stopped, setup changes were made, and data banks were cleared.

The events are listed from the most recent to the oldest. You can scroll through the list a page at a time by selecting the Up and Down arrow buttons and pressing the  button. You can go directly to an event number by highlighting the event number box (left of the UP arrow), pressing the  button, using the arrow buttons to change the number, and pressing the  button.

System Check Screen

Highlight System Check in the Main menu and press the  button. The System Check setup screen appears.

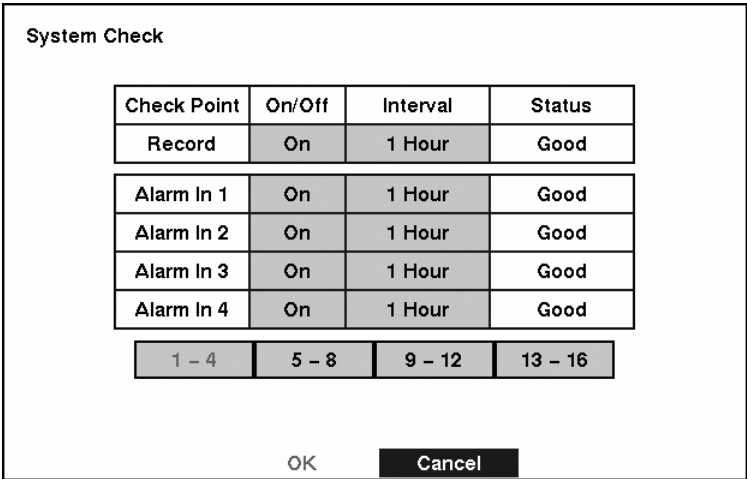

Figure 29 — System Check screen.

Highlight the box under the On/Off heading and press the button. This toggles between On and Off. When it is On, the DVR reports a fault condition if it does not detect any recording or if there is an alarm during the designated time.

Highlight the box under the Interval heading and press the button. A slide bar appears allowing you to set the check interval from 1 Hour to 30 Days by using the Left and Right arrow buttons.

The Status field displays the fault conditions. When it is Good, there was recording or an alarm occurred during the designated time. When it is Bad, there was no recording or no alarm occurred during the designated time.

Configuring Input Devices

You can configure the video, audio and remote control devices connected to the DVR.

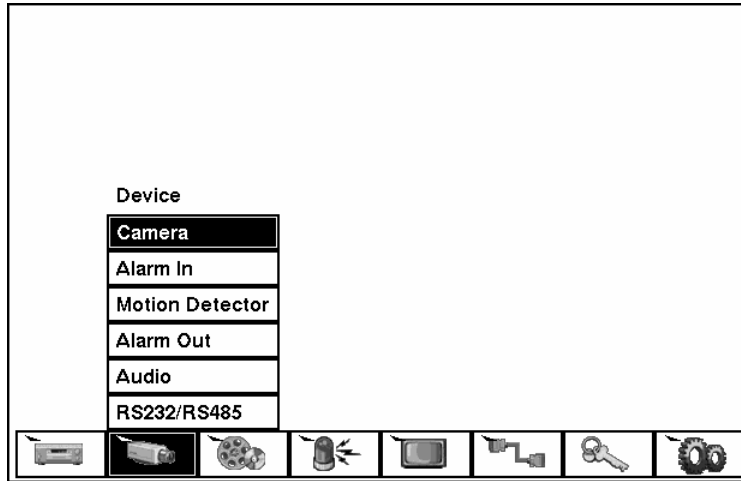



Figure 30 — Device menu screen.

Camera Setup Screen

Highlight Camera in the Main menu and press the  button. The Camera setup screen appears.

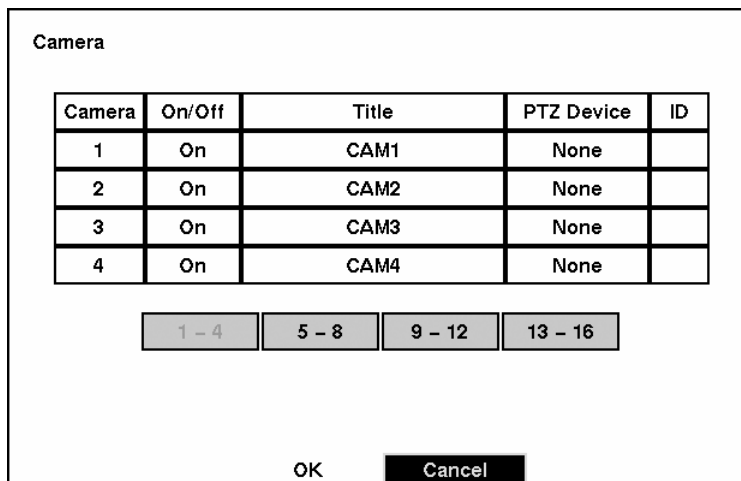

Figure 31 — Camera setup screen.

The **Camera** setup screen displays the camera inputs in groups of four: 1-4, 5-8, 9-12 and 13-16. In this screen you can tell the DVR which input connectors have cameras attached by turning the camera number **On** or **Off**.

You can assign titles to each camera by highlighting the camera title box and pressing the button. A virtual keyboard allows you to enter camera names.

Selecting the **PTZ Device** box causes a list of controllable cameras to display. Select your camera from the list and press the button. You will need to connect the camera to the RS485 terminal on the back of the DVR following the camera manufacturer's instructions.



Figure 32 — PTZ Device list.

NOTE: See *Chapter 2 – Installation* for information on connecting the PTZ camera to the RS485 connector.

Alarm In Setup Screen

Highlight Alarm In in the Main menu and press the  button. The Alarm In setup screen appears.

Alarm In

Alarm In	On/Off	Title	NC/NO
1	Off		NC
2	Off		NC
3	Off		NC
4	Off		NC

1 - 4

5 - 8

9 - 12

13 - 16





OK
Cancel

Figure 33 — Alarm In setup screen.

The alarm terminal strip on the back of the DVR has inputs associated with each alarm. You can set up each input on the Alarm In Setup screen. The inputs are displayed in groups of four. You can turn each input On or Off. Each input can be given a title, and the inputs can be set as NO (normally open) or NC (normally closed) independently.

Motion Detector

Motion Detector

Camera	On/Off	Sensitivity	Zone	Min Size	View
1	On	3		10	Off
2	On	3		10	Off
3	On	3		10	Off
4	On	3		10	Off

1 - 4

5 - 8

9 - 12

13 - 16

OK
Cancel

Figure 34 — Motion Detector setup screen.

Your DVR has built-in video motion detector. Video motion detector can be turned On or Off for each camera.

Highlighting the box under the **Sensitivity** heading allows you to adjust the DVR's sensitivity to motion. There are five settings with 1 being the least sensitive and 5 being the most sensitive.

You can adjust the minimum number of detection blocks that must be activated to trigger a motion alarm. Highlight a box under the **Min Size** heading and adjust the number. The smaller the number, fewer detection blocks must be activated and therefore more sensitive.

Turning the **View** setting On will allow you to observe how the DVR is reacting to motion. When in the motion viewing mode, the detection zone of video will be displayed in green. Any detected motion within the zone will be displayed in red.

You can define the area of the image where you want to detect motion; e.g., a doorway. Highlight the icon under the **ZONE** heading, and press the  button. The Motion Detection Zone screen will display.

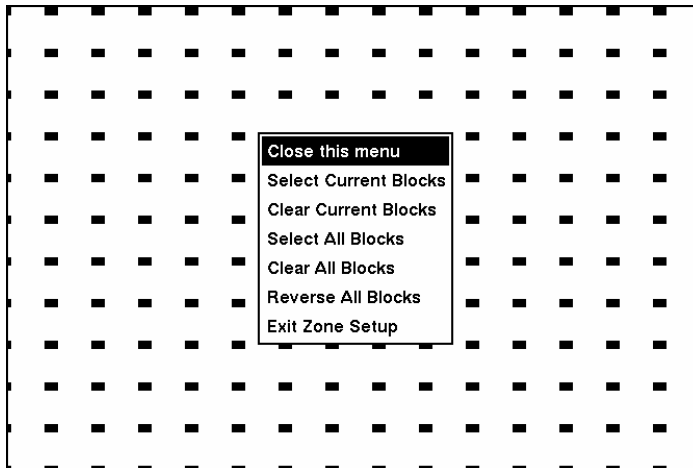

Figure 35 — Motion Detection Zone screen.

The Motion Detection Zone screen is laid over the video for the selected camera. You can set up motion detection zones by selecting or clearing blocks. The menu on the setup screen has the following functions:

NOTE: Use the camera buttons to activate or deactivate individual cells.

Close this menu — Closes the menu so that you can see the entire screen.

Select Current Blocks — Activates highlighted blocks to detect motion.

Clear Current Blocks — Deactivates highlighted blocks so that they will not detect motion.

Select All Blocks — Activates all blocks to detect motion.

Clear All Blocks — Deactivates all blocks so that they will not detect motion.

Reverse All Blocks — Activates inactive blocks and deactivates active blocks.

Exit Zone Setup — Asks you to confirm changes and then returns to the previous screen.

Alarm Out Setup Screen

The Alarm Out setup screen allows you to establish a schedule for each alarm output from the DVR.

The screenshot shows a window titled "Alarm Out" containing a table with three columns: "Alarm Out", "Title", and "Sched". There are five rows in the table. The first four rows have "1", "2", "3", and "4" in the "Alarm Out" column and empty boxes in the "Title" column. The "Sched" column for all five rows contains a checked checkbox. The fifth row has "Beep" in both the "Alarm Out" and "Title" columns. Below the table are two buttons: "OK" and "Cancel".

Alarm Out	Title	Sched
1		<input checked="" type="checkbox"/>
2		<input checked="" type="checkbox"/>
3		<input checked="" type="checkbox"/>
4		<input checked="" type="checkbox"/>
Beep	Beep	<input checked="" type="checkbox"/>

Figure 36 — Alarm Out setup screen.

Each alarm output can be given its own title by highlighting the box under the **Title** heading and pressing the button. A virtual keyboard appears allowing you to enter the title.

Highlighting the **Sched** field and pressing the button opens a schedule screen. You can schedule alarm output in 30-minute increments from 0:00 to 24:00.

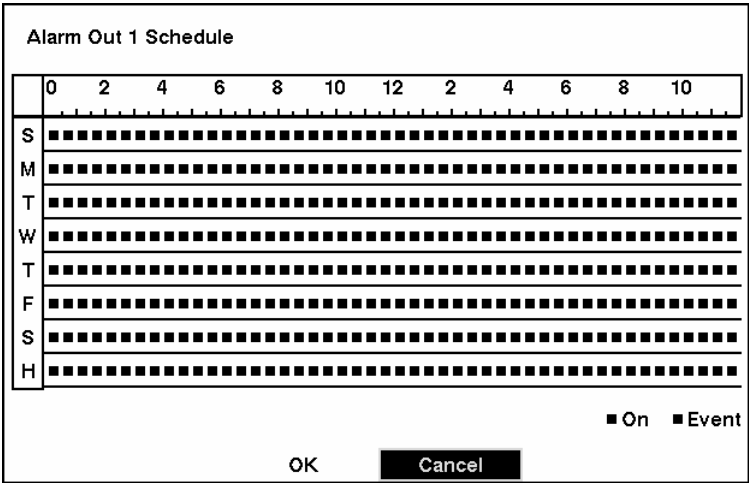



Figure 37 — Alarm Out Schedule screen.

You can select individual blocks of time, entire days of the week, entire blocks of time or the entire schedule. Select a specific block of time by highlighting it. Select an entire day by highlighting the day of the week or Holiday on the left of the screen. Select an entire block of time by highlighting the time at the top of the screen. Select the entire screen by highlighting the empty box in the upper left corner of the screen. Press the button from No Arming (no block) to On (blue block) to Event (yellow block).

When set to On, the Alarm Out is active during the scheduled time. When set to Event, the Alarm Out is only active when there is an Event during the scheduled time.

Audio Setup Screen

Highlight Audio in the Main menu and press the  button. The Audio Setup screen appears.

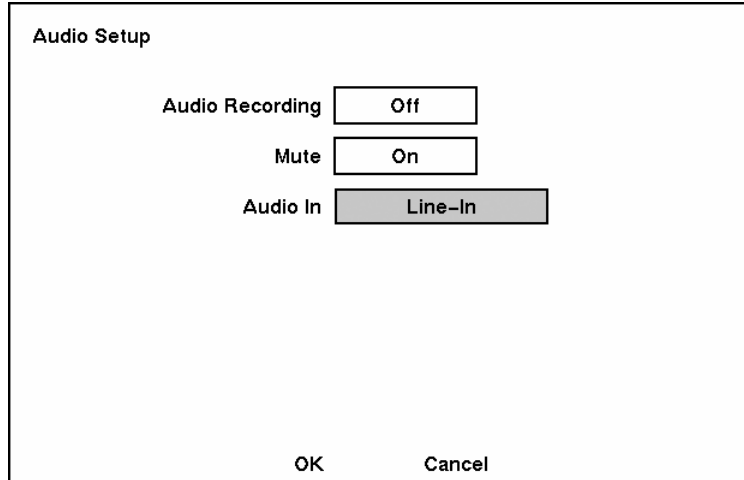





Figure 38 — Audio Setup screen.

Highlight the box beside Audio Recording and press the  button. This toggles between On and Off. When it is On, the DVR also records audio when it is recording video.

Highlight the box beside Mute and press the  button. This toggles between On and Off. When it is On, the DVR will NOT play live or recorded audio.

Highlight the box beside Audio In. Pressing the  button toggles between Mic In and Line In. Mic In is for an unamplified source while Line In is for an amplified source.

You can save your changes by highlighting OK and pressing the  button. Selecting Cancel exits the screen without saving the changes.

NOTE: The DVR will NOT record audio when the recording speed is set to less 1 ips.

RS232/RS485 Setup Screen

The RS232/RS485 setup screen allows you to set up the RS232 and RS485 ports to communicate with external devices such as modems, remote controls and dome cameras.

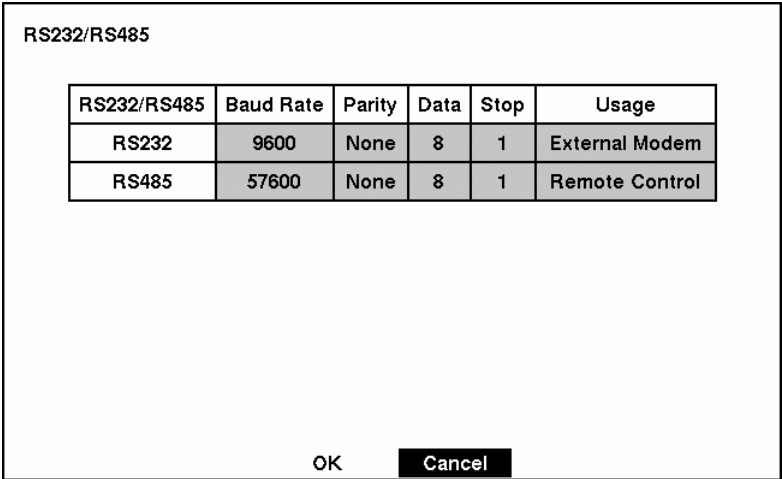

Figure 39 — RS232/RS485 setup screen.

Highlight the field for the settings you wish to make. Select the correct Baud Rate, Parity, Data Bits and Stop Bits for the device you are connecting to the DVR.

For RS485, it is possible to select either Remote Control or PTZ Control in the Usage field.

Configuring Recording Settings

NOTE: Pressing the **REC** button on the front of the DVR will cause the red LED to light and indicates the DVR is ready to record. However, this does not mean the DVR is recording. The DVR records video based on the parameters such as schedule and events defined during configuration. The record indicator on the front display panel lights when the DVR is recording.

Your DVR offers a variety of flexible recording modes. You can set it up to record all the time or to only record events. It can be set up to continue recording once the hard disk drive is full by recording over the oldest video, or you can set it up to alert you when the hard disk is full and stop recording.

Record Mode Setup Screen

The image shows a 'Record Mode Setup' screen with the following settings:

End Of Disk	Stop
On Disk Full :	
Beep	Off
Alarm Out	Off
Mode	Simplex
Field Detect	On
OK	Cancel

Figure 40 — Record Mode Setup screen.

Highlight the box beside End Of Disk and press the **←** button. This toggles between Stop and Overwrite. When in the Stop mode, the DVR stops recording when the hard disk drive is full. When in the Overwrite mode, the DVR continues recording when the hard disk drive is full by overwriting the oldest video.

If the DVR is set to the Stop mode, you can set it to beep or activate the Alarm Out AO1 port when the hard disk drive is full. Highlight the box beside On Disk Full: Beep and press the **←** button to toggle between On and Off. Highlight the box beside On Disk Full: Alarm Out and press the **←** button to toggle between On and Off.

Highlight the box beside Mode. Pressing the button toggles between Simplex and Duplex. In the Simplex mode, the DVR can record up to 60 images per second for NTSC (50 for PAL). However, in the Simplex mode, you can only record or play back video, but not both. In the Duplex mode, you can record and play back video at the same time. However, you can only record up to 30 images per second for NTSC (25 for PAL) while in the Duplex mode.

NOTE: The maximum playback speed is 30ips (25ips PAL) while playing back video in the Duplex mode even if it was recorded at 60ips (50ips PAL) in the Simplex mode. Video that was recorded at 60 ips for NTSC (50 ips for PAL) in the Simplex mode will play back slower in the Duplex mode, and will have poor quality audio.

Highlight the box beside Field Detect. Pressing the button toggles between On and Off. When set to On, the Field Detection helps prevent shaking in the Simplex mode. It does this by recording odd numbered fields from odd numbered cameras and even numbered fields from even numbered cameras.

You can save your changes by highlighting OK and pressing the button. Selecting Cancel exits the screen without saving the changes.

Time-Lapse Record Mode Setup Screen

Time-Lapse Record Setup

Camera	Sched	Mode 1		Mode 2	
		Speed	Quality	Speed	Quality
1	<input checked="" type="checkbox"/>	60 ips	Standard	60 ips	Standard
2	<input checked="" type="checkbox"/>	60 ips	Standard	60 ips	Standard
3	<input checked="" type="checkbox"/>	60 ips	Standard	60 ips	Standard
4	<input checked="" type="checkbox"/>	60 ips	Standard	60 ips	Standard

1 - 4

5 - 8

9 - 12

13 - 16

Keep the continuous pictures

Off
 1 Hour

Figure 41 — Time-Lapse Record Setup screen.

Highlight the box under Speed and press the button. A drop-down list of record speeds appears. You can select from 1 image per 10 seconds to 60 images per second for NTSC (to 50 images per second PAL). You can set two modes. The modes are used when scheduling the DVR. For example, you might use Mode 1 during operating hours and Mode 2 when the facilities are closed.

NOTE: If you have set the DVR for Duplex mode, you will not be able to select 60 ips NTSC (50 ips PAL).

Highlight the box under Quality and press the button. A drop-down list appears. You can select from Very High, High, Standard and Low image quality. All other variables being equal; Very High will require 600% more hard disk space than Standard, High will require 250% more, and Low 30% less.

NOTE: Higher quality images require more storage space and will reduce the recording capacity of the hard disk drive.

You can set the maximum amount of time-lapse video to be stored. Once the DVR reaches this amount, it will start recording over the oldest time-lapse video. The time lapse video is stored separate from Event video.

When Keep the continuous pictures is set to On, you can set the time from 1 Hour to the maximum allowed by the storage capacity of your hard disk drive.

NOTE: The maximum storage time is only an estimate because the amount of space required to store video varies depending on many factors such as motion and image complexity.

Time-Lapse Recording Schedule

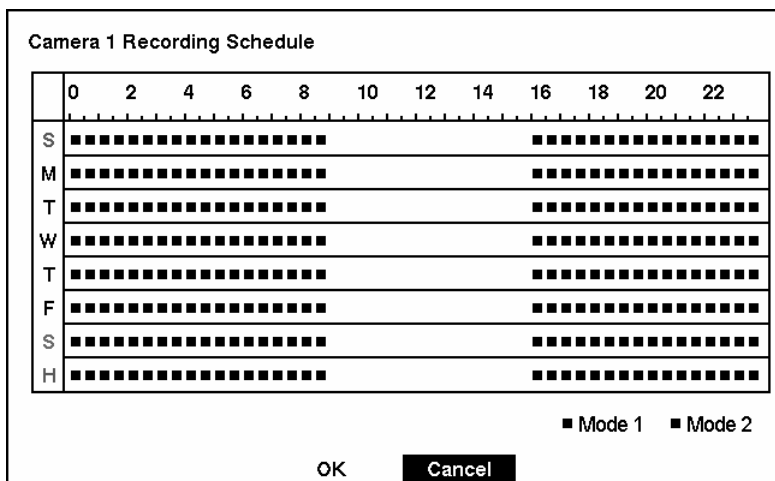







Figure 42 — Time-Lapse Recording Schedule screen.

You can program the DVR to record only during certain times based on time, day of the week, and holidays. The smallest time segment you can use is 30 minutes. A blue rectangle indicates the DVR is set to record during those 30 minutes. When there is no rectangle, the DVR will not record during those 30 minutes.

There are several ways to set recording times:

- You can highlight an individual block and toggle it On or Off by pressing the  button.
- You can change a 30-minute segment for all days by placing the cursor on the time line and pressing the  button to toggle the segment On or Off.
- You can change an entire day by placing the cursor on the day of the week and pressing the  button to toggle the day On or Off.
- You can change the entire calendar by placing the cursor in the upper left-hand box (above “S” and to the left of the time line) and pressing the  button to toggle the entire calendar On and Off.

NOTE: The Holiday (H) schedule applies to the dates you established as holidays when setting Date/Time.

You can save your changes by highlighting OK and pressing the  button. Selecting Cancel exits the screen without saving the changes.

Pre-Event Recording Setup Screen

Pre-Event Record Setup

Camera	On/Off	Speed	Quality	Dwell
1	On	60 ips	High	10 sec
2	On	60 ips	High	10 sec
3	On	60 ips	High	10 sec
4	On	60 ips	High	10 sec

1 - 4

5 - 8

9 - 12

13 - 16

OK

Cancel

Figure 43 — Pre-Event Record Setup screen.

When the DVR is in the Event Record mode it is possible to have it record images before the event occurs. The Pre-Event Record screen allows you to define how to handle pre-event recording.

You can turn individual cameras On or Off for pre-event recording. The image speed can be set from 0.1 to 60 ips (50 ips PAL), and image quality can be selectable from High, Standard and Low.

You can set the amount of time to record prior to the event by adjusting the Dwell. You can set the Dwell from 1 to 300 seconds.

NOTE: When the DVR is in the Time-Lapse mode, it ignores the pre-event settings and follows the time-lapse settings.

Event Action Setup

Highlight the Alarm In Event Action, Motion Detector Event Action, or Video Loss Event Action in the Main menu. The following Event Action setup screens will appear.

Alarm In Event Action (Record) Setup Screen

The DVR can be set to react to events differently. Each sensor can be assigned a schedule, camera, recording speed, video quality and dwell time.

Alarm In Event Action

		Mode 1	Mode 2			
		Record	Alarm Out	Notify		
Sensor	Sched	Camera	Speed	Quality	Dwell	
1	<input checked="" type="checkbox"/>	1	60 ips	Standard	10 sec	
2	<input checked="" type="checkbox"/>	2	60 ips	Standard	10 sec	
3	<input checked="" type="checkbox"/>	3	60 ips	Standard	10 sec	
4	<input checked="" type="checkbox"/>	4	60 ips	Standard	10 sec	

1 - 4 5 - 8 9 - 12 13 - 16

OK Cancel

Figure 44 — Alarm In Event Action (Record) setup screen.

Highlight the Sched box and press the button. A schedule screen appears. Set the schedule as described earlier.

Highlight the Camera box and press the button. A camera selection screen appears. Select the camera number you would like to associate with the sensor.

NOTE: You can associate multiple cameras with a sensor.

Highlight the Speed box and select number of images per second you would like to record from the drop-down menu.

Highlight the Quality box and select the image quality you want to record from the drop-down menu.

Highlight the Dwell box and set the length of time you would like to record for the associated event.

Alarm In Event Action (Alarm Out) Setup Screen

The DVR can be set to react to events differently by activating an internal buzzer or external alarms.

The screenshot shows the 'Alarm In Event Action' setup screen. At the top, there are two tabs: 'Mode 1' and 'Mode 2'. Below them are three sub-sections: 'Record', 'Alarm Out', and 'Notify'. The main part of the screen is a table with the following data:

Sensor	Sched	Alarm Out	Dwell
1	<input checked="" type="checkbox"/>	-	10 sec
2	<input checked="" type="checkbox"/>	-	10 sec
3	<input checked="" type="checkbox"/>	-	10 sec
4	<input checked="" type="checkbox"/>	-	10 sec

Below the table are four buttons for sensor groups: '1 - 4', '5 - 8', '9 - 12', and '13 - 16'. At the bottom are 'OK' and 'Cancel' buttons.

Figure 45 — Alarm In Event Action (Alarm Out) setup screen.

Highlight the Sched box and press the button. A schedule screen appears. Set the schedule as described earlier.

Highlight the Alarm-Out box and either Beep or the alarm output terminal that you want to associate with the sensor.

Highlight the Dwell box and set the length of time you want the output activated.

Alarm In Event Action (Notify) Setup Screen

The DVR can be set to notify the remote site when certain events are activated. (Not available in E Models)

Alarm In Event Action

Mode 1	Mode 2	
Record	Alarm Out	Notify

Sensor	Sched	Notify
1	<input checked="" type="checkbox"/>	Off
2	<input checked="" type="checkbox"/>	Off
3	<input checked="" type="checkbox"/>	Off
4	<input checked="" type="checkbox"/>	Off

1 - 4	5 - 8	9 - 12	13 - 16
-------	-------	--------	---------

OK	Cancel
----	--------

Figure 46 — Alarm In Event Action (Notify) setup screen.

Highlight the Sched box and press the  button. A schedule screen appears. Set the schedule as described earlier.

Highlight the Notify box and press the  button. This toggles between On and Off. When it is On, the DVR notifies the remote site when certain events occur based on a defined schedule.

Motion Detector Event Action (Record) Setup Screen

The DVR can be set to react to motion detector differently. Each camera can be assigned a schedule, associated camera, recording speed, video quality and dwell time.

Motion Detector Event Action					
		Mode 1	Mode 2		
		Record	Alarm Out	Notify	
Camera	Sched	Camera	Speed	Quality	Dwell
1	<input checked="" type="checkbox"/>	1	60 ips	Standard	10 sec
2	<input checked="" type="checkbox"/>	2	60 ips	Standard	10 sec
3	<input checked="" type="checkbox"/>	3	60 ips	Standard	10 sec
4	<input checked="" type="checkbox"/>	4	60 ips	Standard	10 sec

1 - 4 5 - 8 9 - 12 13 - 16

OK Cancel

Figure 47 — Motion Detector Event Action (Record) setup screen.

Highlight the Sched box and press the button. A schedule screen appears. Set the schedule as described earlier.

Highlight the Camera box and press the button. A camera selection screen appears. Select the camera number you would like to associate with the camera.

NOTE: You can associate multiple cameras with a camera that detects motion.

Highlight the Speed box and select number of images per second you would like to record from the drop-down menu.

Highlight the Quality box and select the image quality you want to record from the drop-down menu.

Highlight the Dwell box and set the length of time you would like to record for the associated motion event.

Motion Detector Event Action (Alarm Out) Setup Screen

The DVR can be set to react to motion events differently by activating an internal buzzer or external alarms.

Motion Detector Event Action

		Mode 1	Mode 2
		Record	Alarm Out
		Notify	

Camera	Sched	Alarm Out	Dwell
1	<input checked="" type="checkbox"/>	-	10 sec
2	<input checked="" type="checkbox"/>	-	10 sec
3	<input checked="" type="checkbox"/>	-	10 sec
4	<input checked="" type="checkbox"/>	-	10 sec

1 - 4	5 - 8	9 - 12	13 - 16
-------	-------	--------	---------

OK
Cancel

Figure 48 — Motion Detector Event Action (Alarm Out) setup screen.

Highlight the Sched box and press the button. A schedule screen appears. Set the schedule as described earlier.

Highlight the Alarm-Out box and either Beep or the alarm output terminal that you want to associate with the motion event.

Highlight the Dwell box and set the length of time you want the output activated.

Motion Detector Event Action (Notify) Setup Screen

The DVR can be set to notify the remote site when certain motion events are activated. (Not available in E Models)

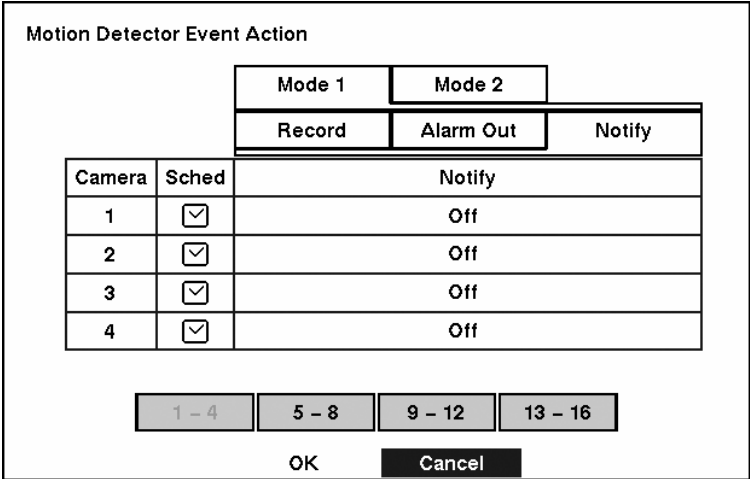

The screenshot shows a menu titled "Motion Detector Event Action". At the top, there are two tabs: "Mode 1" and "Mode 2". Below these are three columns: "Record", "Alarm Out", and "Notify". The main table has four rows for cameras 1 through 4. Each row has a "Camera" column, a "Sched" column with a checked checkbox, and a "Notify" column with the value "Off". At the bottom, there are four buttons labeled "1 - 4", "5 - 8", "9 - 12", and "13 - 16", and two buttons labeled "OK" and "Cancel".

		Mode 1	Mode 2	
		Record	Alarm Out	Notify
Camera	Sched	Notify		
1	<input checked="" type="checkbox"/>	Off		
2	<input checked="" type="checkbox"/>	Off		
3	<input checked="" type="checkbox"/>	Off		
4	<input checked="" type="checkbox"/>	Off		

1 - 4 5 - 8 9 - 12 13 - 16

OK Cancel

Figure 49 — Motion Detector Event Action (Notify) setup screen.

Highlight the Sched box and press the button. A schedule screen appears. Set the schedule as described earlier.

Highlight the Notify box and press the button. This toggles between On and Off. When it is On, the DVR notifies the remote site when certain events occur based on a defined schedule.

Video Loss Event Action (Record) Setup Screen

The DVR can be set to react to video loss from a camera differently. Each camera can be assigned a schedule, associated camera, recording speed, video quality and dwell time.

Video Loss Event Action

		Mode 1	Mode 2		
		Record	Alarm Out	Notify	
Camera	Sched	Camera	Speed	Quality	Dwell
1	<input checked="" type="checkbox"/>	-	60 ips	Standard	10 sec
2	<input checked="" type="checkbox"/>	-	60 ips	Standard	10 sec
3	<input checked="" type="checkbox"/>	-	60 ips	Standard	10 sec
4	<input checked="" type="checkbox"/>	-	60 ips	Standard	10 sec

1 - 4 5 - 8 9 - 12 13 - 16

OK Cancel

Figure 50 — Video Loss Event Action (Record) setup screen.

Highlight the Sched box and press the button. A schedule screen appears. Set the schedule as described earlier.

Highlight the Camera box and press the button. A camera selection screen appears. Select the camera number you would like to associate with the camera that has lost video.

NOTE: You can associate multiple cameras with a camera.

Highlight the Speed box and select number of images per second you would like to record from the drop-down menu.

Highlight the Quality box and select the image quality you want to record from the drop-down menu.

Highlight the Dwell box and set the length of time you would like to record for the associated video loss.

Video Loss Event Action (Alarm Out) Setup Screen

The DVR can be set to react to video loss differently by activating an internal buzzer or external alarms.

Video Loss Event Action

		Mode 1	Mode 2	
		Record	Alarm Out	Notify
Camera	Sched	Alarm Out		
1	<input checked="" type="checkbox"/>	Beep		
2	<input checked="" type="checkbox"/>	Beep		
3	<input checked="" type="checkbox"/>	Beep		
4	<input checked="" type="checkbox"/>	Beep		

1 - 4 5 - 8 9 - 12 13 - 16

OK **Cancel**

Figure 51 — Video Loss Event Action (Alarm Out) setup screen.

Highlight the Sched box and press the button. A schedule screen appears. Set the schedule as described earlier.

Highlight the Alarm-Out box and either Beep or the alarm output terminal that you want to associate with the camera that has lost video.

Video Loss Event Action (Notify) Setup Screen

The DVR can be set to notify the remote site in the case of video loss. (Not available in E Models)

Video Loss Event Action

Mode 1	Mode 2	
Record	Alarm Out	Notify

Camera	Sched	Notify
1	<input checked="" type="checkbox"/>	Off
2	<input checked="" type="checkbox"/>	Off
3	<input checked="" type="checkbox"/>	Off
4	<input checked="" type="checkbox"/>	Off

OK Cancel

Figure 52 — Video Loss Event Action (Notify) setup screen.

Highlight the Sched box and press the  button. A schedule screen appears. Set the schedule as described earlier.

Highlight the Notify box and press the  button. This toggles between On and Off. When it is On, the DVR notifies the remote site when it loses video input from a camera based on a defined schedule.

OSD (On-Screen Display) Setup

The DVR can be set up to display Date, Time, Title and Status on screen. Each feature can be turned on or off, and you can adjust the margins.

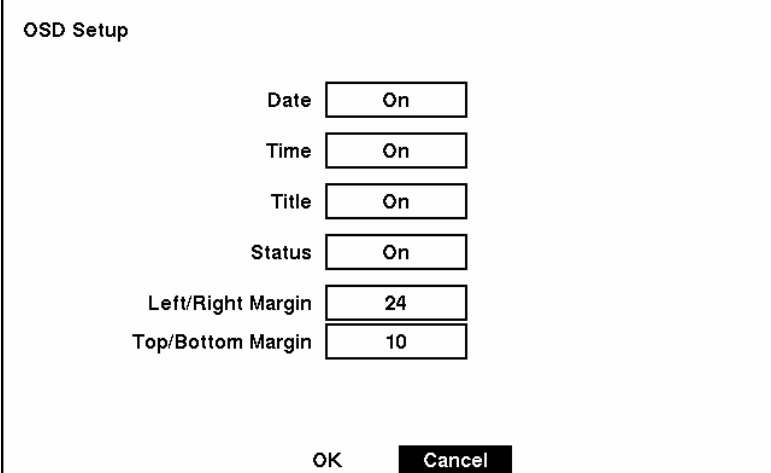

The image shows a screenshot of the OSD Setup screen. The title 'OSD Setup' is in the top left corner. Below it, there are six rows of settings, each with a label and a value in a rectangular box:

- Date: On
- Time: On
- Title: On
- Status: On
- Left/Right Margin: 24
- Top/Bottom Margin: 10

At the bottom of the screen, there are two buttons: 'OK' and 'Cancel'.

Figure 53 — OSD Setup screen.

Highlight the box beside **Date** and press the button to toggle the date display On and Off.

Highlight the box beside **Time** and press the button to toggle the time display On and Off.

Highlight the box beside **Title** and press the button to toggle the camera title display On and Off.

Highlight the box beside **Status** and press the button to toggle status display On and Off.

Highlight the box beside **Left/Right Margin** and press the button to adjust the left and right margins. The margins can be set from 1 to 24.

Highlight the box beside **Top/Bottom Margin** and press the button to adjust the top and bottom margins. The margins can be set from 1 to 24.

Sequence Display Setup Screen

You can adjust the display dwell time for each camera when the DVR is setup to sequence through the cameras. You can also turn Camera Sequence On and Off.

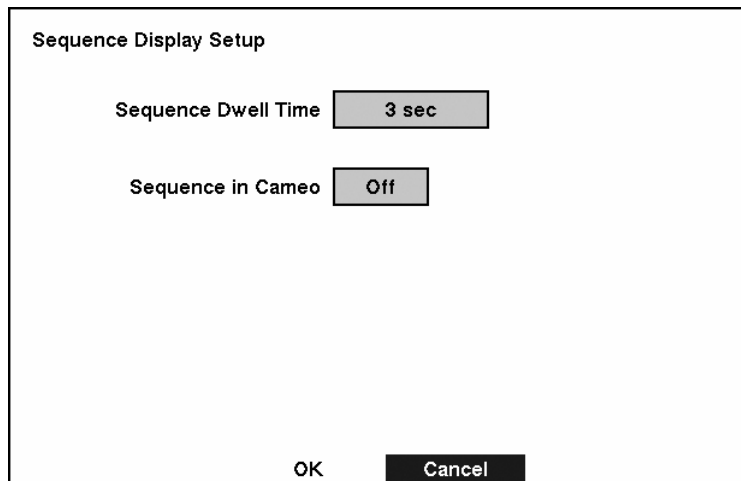

Figure 54 — Sequence Display setup screen.

Highlight the box beside **Sequence Dwell Time** and press the button. You can adjust the display dwell time from 3 to 60 seconds.

Highlight the box beside **Sequence in Cameo** and press the button to toggle between On and Off. (Not on 4-camera model.)

Pressing the **SEQUENCE** button causes the DVR to sequence cameras, and the DVR can sequence cameras in two modes: "Page" and "Cameo". In the Page mode, the DVR sequences through user-defined screen layouts (pages). In the Cameo mode, the bottom right window in a multi-screen format sequences through all cameras.

NOTE: The DVR does not sequence the camera having video loss in the Cameo mode.

You can define the screen layout in a variety of formats and set the DVR to sequence through the different screen layouts (pages) so that all the cameras will be displayed. You can also set up the DVR to display one camera or a group of cameras all the time while cycling through the remaining cameras in a "cameo" window. This can be done with one camera displayed full screen while displaying the cameo window as a PIP (picture in picture), or displaying the cameras in a grid pattern with the bottom right window as the cameo.

NOTE: Sequence cannot be used in the 4x4 display mode of the 16-channel, 3x3 mode of the 9-channel and the 2x2 mode of the 4-channel DVR.

Network Setup Screen

NOTE: The network features can be set only on the Networkable Model DVR. The network features are “grayed” out and inactive on the non-E Model.

In the Network Setup screen you can set up the DVR for LAN connections.

Network Setup

Connection	LAN	Setup...
Admin Password	*****	
User Password	*****	

OK Cancel

Figure 55 — Network Setup screen.

Highlight the box beside **Connection**. Press the button to toggle between LAN and Modem.

Highlight the box beside **Admin Password** and press the button. A virtual keyboard appears. You will first be asked to enter the current password. Then you can enter a new password; you will be asked to confirm the new password before it is accepted.

Highlight the box beside **User Password** and press the button. A virtual keyboard appears. You will first be asked to enter the current password. Then you can enter a new password; you will be asked to confirm the new password before it is accepted.

NOTE: These passwords are for network use. They are different from the Admin and User passwords for the DVR itself.

NOTE: The passwords are case sensitive. The factory default password for both Administrator and User is **12345678**.

CAUTION: Write the password down and keep it in a safe place. Once the password has been reset, the default will no longer work. If the password is forgotten, the unit must be reset using the *Factory Reset Button* and all data settings will be lost.

LAN Setup Screen

The screenshot shows a 'LAN Setup' screen with a digital clock in the top right corner displaying '4:58:11 PM'. The screen contains three input fields for network configuration:

IP Address	192.168.1.10
Gateway	192.168.1.1
Subnet Mask	255.255.255.0

At the bottom of the screen, there are two buttons: 'OK' and 'Cancel'.

Figure 56 — LAN Setup screen.

NOTE: You will need to get the appropriate IP Address, Gateway and Subnet Mask from your network administrator.

Change the numbers by highlighting them and using the Up and Down arrow buttons to increase or decrease the number.

The factory default LAN settings are:

IP Address: 192.168.1.129
Gateway: 192.168.1.254
Subnet Mask: 255.255.255.0

You can save your changes and return to the Network Setup screen by highlighting OK and pressing the  button. Selecting Cancel exits the screen without saving the changes.

Modem Setup

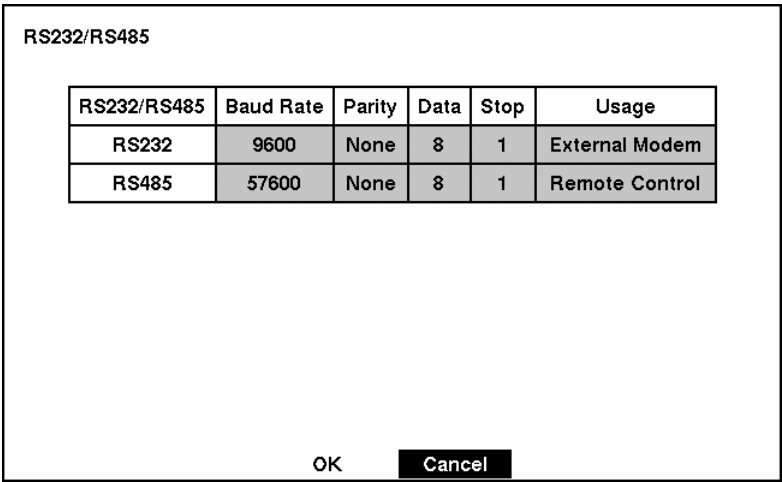

Figure 57 — RS232/RS485 setup screen.

NOTE: Modem setup is done through the *RS232/RS485* screen in the *Devices* menu which can be accessed from the *Main Menu*.

Highlight the box beside **Baud Rate** of the **RS232** field and press the button. A list of baud rates ranging from 300 to 115,200 appears.

Highlight the box beside **Parity** of the **RS232** field and press the button. A drop-down list appears. You can select from **None**, **Odd** or **Even** parity.

Highlight the box beside **Data Bit** of the **RS232** field. Pressing the button toggles between 7 bit and 8 bit formats.

Highlight the box beside **Stop Bit** of the **RS232** field. Pressing the button toggles between 1 and 2 Stop Bits.

You can save your changes by highlighting **OK** and pressing the button. Selecting **Cancel** exits the screen without saving the changes.

Callback Center (LAN) Setup Screen

The screenshot shows a window titled "Callback Center Setup". Inside the window, there are two input fields. The first field is labeled "IP Address" and contains the text "192.168.1.10". The second field is labeled "Retry" and contains the number "3". At the bottom of the window, there are two buttons: "OK" and "Cancel".

Figure 58 — Callback Center (LAN) Setup screen.

NOTE: Callback Center (LAN) is not available on the E Series DVRs

The DVR can be set up to contact a computer running RAS (Remote Administration System) on a LAN when an event occurs.

Highlight the box beside **IP Address** and enter the IP address of the computer you want contacted during an event.

Highlight the box beside **Retry** and enter the number of times you would like the DVR to try contacting the computer. You can select from 1 to 10 retries.

Callback Center (Modem) Setup Screen

Callback Center Setup

Pager Number

Mailbox

Site ID

Event

1 : Alarm In
2 : Motion
3 : Video Loss

OK

Figure 59 — Callback Center (Modem) Setup screen.

NOTE: Callback Center (Modem) is not available on the E Series DVRs

If you have a modem connected to the DVR, it can be set up to dial a pager with a numeric message when an event occurs.

NOTE: The DVR will wait for at least one minute between pages. If another event occurs less than one minute after the DVR has notified a pager, it will not dial the pager. It does this so that the telephone line will not be tied up.

Highlight the box beside **Pager Number** and enter the telephone number of the pager. Enter the number as it must be dialed from your telephone system; e.g., if you must dial “9” for an outside line, enter “9” before the pager number.

Highlight the box beside **Mailbox** and enter the voice mailbox number if your pager uses a voice mailbox.

Highlight the box beside **Site ID** and enter a three-digit site ID number.

When an event occurs, the DVR will dial the pager and leave a four-digit number. The first three digits are the site ID number and the last digit is the type of event. For example, “0753” means that Site 75 has lost video.

You can save your changes by highlighting **OK** and pressing the button. Selecting **Cancel** exits the screen without saving the changes.

Password Setup Screen

An Administrator password is required to turn the system off, enter the setup screen, load default setups, clear all data, change system date and time and change the Administrator password. Highlight Password in the Main menu and press to enter the Password screen.

Permission	On/Off	Password
User	On	*****
Admin Setup		*****

Key Lock On

OK Cancel

Figure 60 — Password setup screen.

Highlight the box beside User and press the button to toggle between On and Off. If the password is set to On, you will be asked to enter the current password so that you can turn it Off. If the password is set to Off, you will be asked to enter the new password and to confirm it before it will be turned on.

The Administrator password cannot be turned On and Off. You can change the Administrator password by first entering the current password, entering a new password and finally confirming the new password.

To change the password, highlight the Password box and press the button. A window appears asking you to enter the current password. If you enter the correct password, another window appears asking you to enter a new password using the camera buttons. After you press the button, another screen appears asking you to confirm the new password.

NOTE: The Admin and User passwords are composed of up to eight digits using the camera buttons. The default Admin password is: **4321**.

CAUTION: Write down the new password and save it in a secure place. If the password is forgotten, the unit must be reset using the *Factory Reset Button* and all data settings will be lost.

To lock front panel buttons, highlight **Key Lock On** and press the  button. Once the buttons are locked, pressing any front panel button will cause a password screen to display. You will need to enter the correct password to unlock the keys. The Key Lock password is **4231**.

You can save your changes by highlighting **OK** and pressing  button. Selecting **Cancel** exits the screen without saving the changes.

Config Screen

The Config menu is used to perform functions such as switching between Quick Setup and System Setup, backing up video, loading default setup and clearing all data.

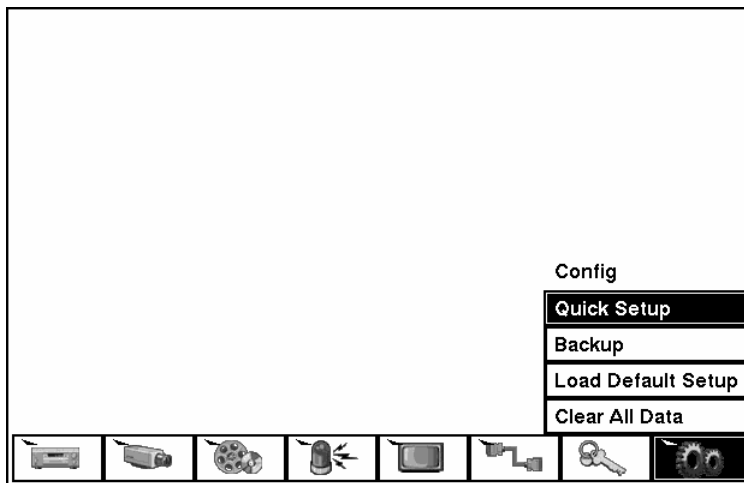

Figure 61 — Config screen.

Backup

The Backup screen can be used to back up video to an external USB hard disk drive.

NOTE: See Appendix A for information on USB hard disk drives.

The Backup screen displays the following configuration options:

From	<input checked="" type="checkbox"/> First	03-22-2002	03:50:51 AM
To	<input checked="" type="checkbox"/> Last	03-22-2002	03:50:51 AM

Camera	<input checked="" type="checkbox"/> 1	<input checked="" type="checkbox"/> 2	<input checked="" type="checkbox"/> 3	<input checked="" type="checkbox"/> 4
	<input checked="" type="checkbox"/> 5	<input checked="" type="checkbox"/> 6	<input checked="" type="checkbox"/> 7	<input checked="" type="checkbox"/> 8
	<input checked="" type="checkbox"/> 9	<input checked="" type="checkbox"/> 10	<input checked="" type="checkbox"/> 11	<input checked="" type="checkbox"/> 12
	<input checked="" type="checkbox"/> 13	<input checked="" type="checkbox"/> 14	<input checked="" type="checkbox"/> 15	<input checked="" type="checkbox"/> 16

File Name

Start

Figure 62 — Backup screen.

The default video segment to be backed up is from the first to last frame. However, you can define how much video to back up by changing the start and end times and dates. You will need to enter a file name before the video will back up. A virtual keyboard appears allowing you to enter a file name.

Load Default Setup

Highlighting and selecting Load Default Setup will bring up screen asking you if you really want to load default settings and confirm it with a password.

NOTE: Loading the Default Setup will not change the current time, time zone, daylight saving time and network settings.

Clear All Data

Highlighting and selecting Clear All Data will bring up screen asking you if you really want to clear all data and confirm it with a password.

CAUTION: Selecting *Clear All Data* will erase all recorded video.

Chapter 4 — Operation

NOTE: This chapter assumes your DVR has been installed and configured. If it has not, please refer to Chapters 2 and 3.

The DVR's controls are similar to a VCR. As with a VCR, the main functions are recording and playing back video. However, you have much greater control over recording and playing back video. You can establish recording schedules based on time of day and day of the week. The DVR allows you to search through the recorded video using much more sophisticated tools than those available with VCRs. Additional DVR features that are not available with VCRs are remote control and viewing, recording video at the same time you are watching previously recorded video, and printing images to a standard printer.

The Front Panel Display and controls are described in *Chapter 3 — Configuration*.

Turning on the Power

Once you have installed the DVR following the instructions in *Chapter 2 — Installation*, it is ready to record. Press the **POWER** button, and the unit will go through its self-diagnostics.

The unit will take approximately 60 seconds to initialize. While it is initializing, the DVR will display HELLO. Then, the HELLO will start moving to the left.

Live Monitoring

As soon as the DVR completes its initialization process, it will begin showing live video on the attached monitor and playing live audio through the attached speaker. The default mode is to display all cameras at once. Pressing any camera button will cause that camera to display full screen. It displays live video and plays live audio until the user enters another mode.

Pressing the **DISPLAY** button cycles the DVR through the different display formats.

Pressing the **SEQUENCE** button will cause the cameras to display sequentially on the monitor. When in one of the multi-view formats, pressing this button will cause the DVR to through user-defined screen layouts (page sequence), or the bottom, right screen to display live cameras sequentially (cameo sequence). Selecting another display mode, or pressing the **SEQUENCE** button again will exit the Sequence mode.

Pressing the **FREEZE** button will freeze the current image on the screen until you press the button again.

PIP Mode

You can display a Picture-in-Picture by pressing the **DISPLAY** button. You can change the location of the PIP by pressing the **Up** and **Down** arrow buttons and its size by pressing the **Left** and **Right** arrow buttons.

PTZ Mode

The DVR will control cameras with Pan, Tilt and Zoom capabilities. Press the **PTZ** button to enter the PTZ mode. You can control the camera using front panel control buttons or by setting up presets. To use the front panel buttons, press the **Left** and **Right** arrow buttons to pan left and right. Press the **Up** and **Down** arrow buttons to tilt the camera up and down. Press the **SEARCH** button to zoom in, and press the **PLAY/PAUSE** button to zoom out. You can use the **RW** and **FF** buttons to focus the image.

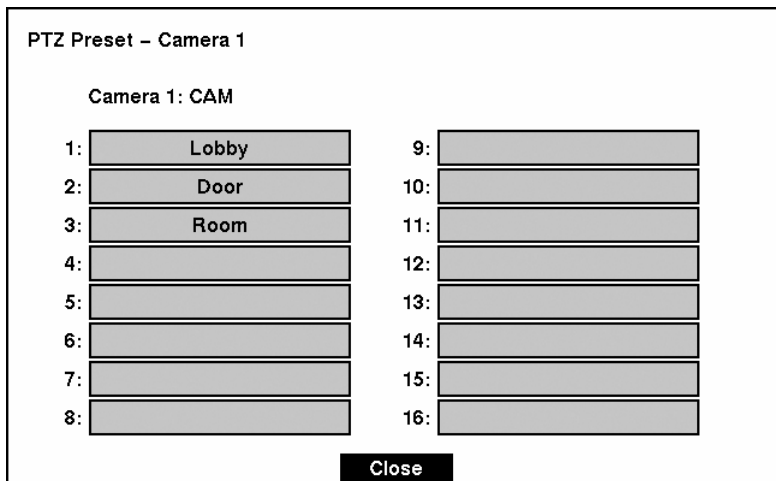

Figure 63 — PTZ Preset screen.

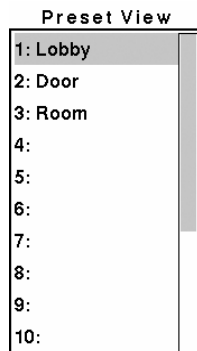

Figure 64 — Preset view screen.

You can save camera position settings as “presets” so that you can go directly to desired views. Once you have the camera at the desired settings, press the **STOP** button, and the PTZ Preset dialog box will appear. Select the number you want to assign to the preset and press the **OK** button. Use the virtual keyboard to enter the preset name. Press the **REC** button to load the PTZ preset and the Preset View dialog box will appear. Select the desired preset and press the **OK** button to load the preset.

Recording Video

Once you have installed the DVR following the instructions in *Chapter 2 — Installation*, it is ready to record. Unless you change the setup, the DVR will start recording when you press the **REC** button and will continue recording until the hard disk drive is full.

Although you will be able to record without changing the unit from its original factory settings, you will want to take advantages of the DVR’s many tools. See *Chapter 3 — Configuration* for detailed descriptions of the recording mode options. Here is a brief description of some of the settings:

- **Stop or Overwrite** when the hard disk drive is full. The factory default is **Stop**. The DVR can be set to continue recording once the hard disk drive is full. It does this by recording over the oldest video.
- **Simplex or Duplex**. The factory default mode is **Simplex** recording. In the Simplex mode you can either record or play back video, but you cannot do both at the same time. In the Duplex mode, you can both record and play back video at the same time. The advantage to the Simplex mode is that you can record at 60 NTSC images per second; while Duplex mode has a recording maximum of 30 NTSC images per second (50 and 25 images per second PAL).

NOTE: The DVR only records video when the red *REC* on the display is lit. The DVR is NOT recording if only the red LED on the REC button is lit. When the DVR is set for *Time-lapse* or *Event* recording, the red LED on the REC button indicates the unit is ready to record. The red *REC* on the display will light and a red dot appears on the monitor when the clock reaches a scheduled recording time and the DVR starts recording video.

Recording Audio

If the DVR was set up to record audio, it will record audio when video is recording.

NOTE: Make certain you comply with all local and federal laws and regulations when recording audio.

Playing Recorded Video

Once video has been recorded, you can view it by pressing the **PLAY/PAUSE** button. When playing video for the first time, the DVR will display the most recent image. When playing video subsequent times, the DVR will start playing video from the last recalled image.

NOTE: If the DVR is set in the *Simplex* mode, you will need to stop recording before playing back video.

Pressing the **PLAY/PAUSE** button again will freeze the video on the screen.

RW (Rewind) Button

Pressing the **RW** button plays video backward at high speed. Pressing the button again toggles the playback speed from **◀◀**, **◀◀◀** and **◀◀◀◀**. The screen displays **◀◀**, **◀◀◀** and **◀◀◀◀** respectively.

Entering Fast Backward Playback mode from Live Monitoring mode can be password protected.

FF (Fast Forward) Button

Pressing the **FF** button plays video forward at high speed. Pressing the button again toggles the playback speed from **▶▶**, **▶▶▶** and **▶▶▶▶**. The screen displays **▶▶**, **▶▶▶** and **▶▶▶▶** respectively.

Entering Fast Playback mode from Live Monitoring mode can be password protected.

STOP Button

Pressing the **STOP** button during Playback mode returns the DVR to the Live Monitoring mode.

Camera Buttons (1 to 16)

Pressing a camera button will display that camera full screen.

DISPLAY Button

Pressing the **DISPLAY** button will cycle the display through the different screen layouts. The display modes are: full, 4x4, 3x3, and 2x2 (not all formats are available for the 9- and 4- channel DVRs).

NOTE: You cannot change the display format while playing back video. Pause the video first, then change the format.

Shuttle Ring

The Shuttle Ring only functions in the Playback mode. The Shuttle Ring is spring loaded and returns to the center position when released. Turning the ring clockwise plays video forward. Turning the ring counterclockwise plays video backward. Playback speed varies with the amount the ring is turned. The playback speeds are ◀x0.5, ◀◀, ◀◀◀, ◀◀◀◀, ▶x0.5, ▶, ▶▶, ▶▶▶ and ▶▶▶▶.

When you release the ring, it snaps back to the center position and the video pauses.

Jog Dial

The Jog Dial only functions when playback video has been paused. By turning the jog dial clockwise, you can play video forward image-by-image. By turning the jog dial counterclockwise, you play video backward image-by-image.

Searching Video

Pressing the **SEARCH** button displays the Search Menu.



Figure 65 — Search Menu.

- Go to First — Displays the first recorded image
- Go to Last — Displays the last recorded image
- Date/Time Search... — Searches by date and time (see below for more details)
- Calendar Search... — Searches using a calendar (see below for more details)
- Event Search... — Selects video from the event log (see below for more details)
- Print... — Prints selected images (see below for more details)

Date/Time Search

The screen is titled "Date/Time Search". Below the title, it says "Enter Date/Time:". There are two input fields: the first contains "01-21-2002" and the second contains "07:04:55 AM". Below these fields are two buttons: "OK" and "Cancel".

Figure 66 — Date/Time Search screen.

Move the cursor over the date and press the button. You can use the **Left** and **Right** arrow buttons to highlight the year, month and day. Use the **Up** and **Down** arrow buttons to change to the date you want to search for video. Once you have set the date you want, press the button.

Move the cursor over the time and press the button. You can use the **Left** and **Right** arrow buttons to highlight the hour, minutes and seconds. Use the **Up** and **Down** arrow buttons to change to the time you want to search for video. Once you have entered the time you want, press the button.

Once you have set the date and time you want to search, highlight the button and press the button. The selected date and time will display. (If no video was recorded at the selected time, a blank screen will display.) The , , , Jog and Shuttle can now be used to review the surrounding video.

Calendar Search

The screen is titled "Calendar Search". It shows a calendar grid for the month of December 2002. The days of the week are listed as SUN, MON, TUE, WED, THU, FRI, SAT. The dates 1 through 31 are displayed in the grid. Below the calendar is a time axis with markers at 0, 2, 4, 6, 8, 10, 12, 2, 4, 6, 8, 10. Below the axis are two buttons: "Go" and "Cancel".

Figure 67 — Calendar Search screen.

Days with recorded video display on the calendar with white numbers. You can highlight the days with recorded video by using the arrow buttons. Once you have highlighted a day, press the **[←]** button to select it.

A time bar will display at the bottom of the calendar. Hours in which video was recorded will be highlighted with blue. You can use Up and Down arrow buttons to highlight the time bar. Once the time bar is highlighted, you can select the time by using the Left and Right arrow buttons.

NOTE: The time bar is in one-hour segments. If a segment is highlighted, it means that some video was recorded during that hour. However, it does NOT mean video was recorded for the entire hour.

Once you have set the date and time you want to search, highlight the GO button and press the **[←]** button. The selected date and time will display. The **[PLAY/PAUSE]**, **[RW]**, **[FF]**, Jog and Shuttle can now be used to review the surrounding video.

Event Search

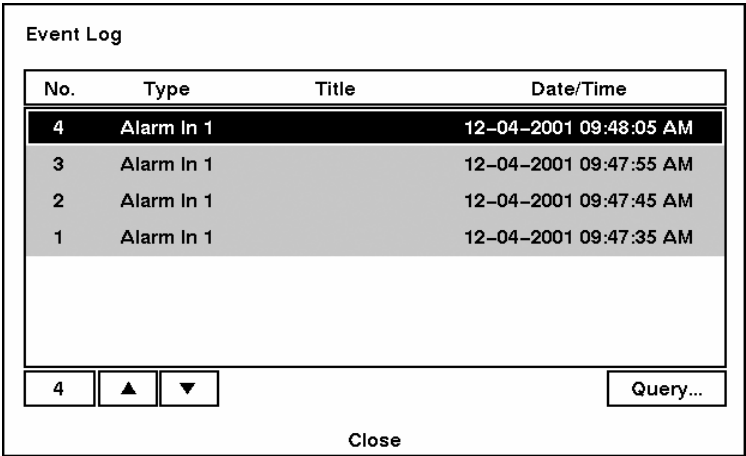

Figure 68 — Event Log screen.

The DVR maintains a log of each time the Alarm Input port is activated. The Event Log screen displays this list. Use the arrow buttons to highlight the event for which you would like to see video.

Pressing the **[←]** button will extract the event video and display the first image of the event. Pressing the **[PLAY/PAUSE]** button will start playing the “event” video segment. Pressing **[STOP]** returns to live monitoring. Pressing **[SEARCH]** returns to the Event Log.

You can also narrow your event search by selecting the Query... button and setting up the new search condition.

Event Search

Search By

From	<input checked="" type="checkbox"/> First	01-24-2002	01:56:57 AM
To	<input checked="" type="checkbox"/> Last	01-24-2002	01:56:57 AM

Camera				Event
<input checked="" type="checkbox"/> 1	<input checked="" type="checkbox"/> 2	<input checked="" type="checkbox"/> 3	<input checked="" type="checkbox"/> 4	<input checked="" type="checkbox"/> Alarm-In
<input checked="" type="checkbox"/> 5	<input checked="" type="checkbox"/> 6	<input checked="" type="checkbox"/> 7	<input checked="" type="checkbox"/> 8	<input checked="" type="checkbox"/> Motion
<input checked="" type="checkbox"/> 9	<input checked="" type="checkbox"/> 10	<input checked="" type="checkbox"/> 11	<input checked="" type="checkbox"/> 12	<input checked="" type="checkbox"/> Video Loss
<input checked="" type="checkbox"/> 13	<input checked="" type="checkbox"/> 14	<input checked="" type="checkbox"/> 15	<input checked="" type="checkbox"/> 16	

Figure 69 — Event Search (by Camera) screen.

Event Search

Serach by

From	<input checked="" type="checkbox"/> First	04-08-2002	11:28:37 PM
To	<input checked="" type="checkbox"/> Last	04-08-2002	11:28:37 PM

	1	2	3	4	5	6	7	8	9	10	11	12	13	14	15	16
Alarm In	<input checked="" type="checkbox"/>	<input checked="" type="checkbox"/>	<input checked="" type="checkbox"/>	<input checked="" type="checkbox"/>	<input checked="" type="checkbox"/>	<input checked="" type="checkbox"/>	<input checked="" type="checkbox"/>	<input checked="" type="checkbox"/>	<input checked="" type="checkbox"/>	<input checked="" type="checkbox"/>	<input checked="" type="checkbox"/>	<input checked="" type="checkbox"/>	<input checked="" type="checkbox"/>	<input checked="" type="checkbox"/>	<input checked="" type="checkbox"/>	<input checked="" type="checkbox"/>
Motion	<input checked="" type="checkbox"/>	<input checked="" type="checkbox"/>	<input checked="" type="checkbox"/>	<input checked="" type="checkbox"/>	<input checked="" type="checkbox"/>	<input checked="" type="checkbox"/>	<input checked="" type="checkbox"/>	<input checked="" type="checkbox"/>	<input checked="" type="checkbox"/>	<input checked="" type="checkbox"/>	<input checked="" type="checkbox"/>	<input checked="" type="checkbox"/>	<input checked="" type="checkbox"/>	<input checked="" type="checkbox"/>	<input checked="" type="checkbox"/>	<input checked="" type="checkbox"/>
Video Loss	<input checked="" type="checkbox"/>	<input checked="" type="checkbox"/>	<input checked="" type="checkbox"/>	<input checked="" type="checkbox"/>	<input checked="" type="checkbox"/>	<input checked="" type="checkbox"/>	<input checked="" type="checkbox"/>	<input checked="" type="checkbox"/>	<input checked="" type="checkbox"/>	<input checked="" type="checkbox"/>	<input checked="" type="checkbox"/>	<input checked="" type="checkbox"/>	<input checked="" type="checkbox"/>	<input checked="" type="checkbox"/>	<input checked="" type="checkbox"/>	<input checked="" type="checkbox"/>

Figure 70 — Event Search (by Event) screen.

Highlight the box beside Search by and press the button to toggle between Camera and Event.

You can search video from the first to last recorded images, or you can set the start and stop times and dates.

When you select the Search by Camera, select the target cameras and event options. When you select the Search by Event, select event options for each device.

Once you set your desired search conditions, highlight Search and press the button to display the search results in the Event Log screen. Selecting Cancel exits the screen without saving the changes.

Printing

Print

Last Played Image Time

Printing Job Image Time

Printing Job Print Time

Figure 71 — Print screen.

It is possible to print images to a PostScript™ printer. Pause the video on the desired image and press the **SEARCH** button. Select Print... from the menu, and the Print screen appears. The date and time of the paused images displays in the Last Played Image Time box. Selecting Start will begin printing the image.

Archiving

Backup

From First 03-22-2002 03:50:51 AM

To Last 03-22-2002 03:50:51 AM

Camera 1 2 3 4

5 6 7 8

9 10 11 12

13 14 15 16

File Name

Figure 72 — Backup screen.

It is possible to archive video to an external USB-IDE hard disk drive. The archived images can be viewed on computers running Microsoft Windows 98, ME or 2000. Refer to the *Appendix A — USB Hard Disk Drive Preparation* for information on preparing the external drive for archiving.

CAUTION: Do NOT disconnect the USB cable or the power from the external drive while archiving video. If the external drive is shut down or the USB cable is disconnected while archiving, THE DVR SYSTEM MAY NOT WORK NORMALLY OR THE EXTERNAL DRIVE COULD BE DAMAGED, and you will get an error message the next time you try to archive. You will need to power down the DVR and restart it to get rid of the error message. Once the file system of the USB-IDE hard disk drive has been corrupted, this error message cannot be dismissed. Even after restarting the DVR it may automatically restart while preparing a backup. You must recover the file system by using the recovery program, or you must reformat the hard disk drive.

You can choose to archive video from the first to last recorded images, or you can set the start and stop times and dates. You can also select which camera you wish to archive.

Highlight the File Name box and press the  button. A virtual keyboard appears. Enter a file name for the video you are archiving and select **Close**. The DVR will automatically add the camera number (for example “01”) and “.exe” to the file name. If you want to save the file in a specific folder, enter the folder name followed by a “/”. For example: “folder/filename”

Once you have given the video a file name, highlight the **Start** button and press the  button.

The DVR will display the USB drive capacity, the backup file size and ask if you want to continue.

NOTE: Do not back up files larger than 2GB.

During archiving the title bar will first display **Preparing backup**, then it will show the progress. Once archiving is complete, the title bar will display **Backup is completed**.

You can end the archiving process at any time by highlighting the **Cancel** button and pressing the  button.

You can use other functions on the DVR while video is being archived. To do this, highlight the **Close** button and press the  button. You can return to the **Backup** screen at any time to check the progress.

Refer to *Appendix B — Reviewing Backup Images* for instructions on how to review the images you have archived.

NOTE: Any recorded audio will not be backed up.

Appendix A — USB Hard Disk Drive Preparation

NOTE: The following USB drives have been tested successfully with the DVR:

IOMEGA Zip250
Sarotech Flex-HDD, FHD-253
Skymaster DEL-2041
Maxtor 3000LE

Preparing the USB-IDE hard disk drive in Windows2000

1. Connect the USB-IDE hard disk drive to your computer using the USB Cable.
2. Turn on your computer.
3. The USB device icon should display on the Taskbar.
4. If the USB-IDE hard disk drive is partitioned or has data, it will show up in *My Computer* as a hard disk drive icon. Check the file system by right clicking on the icon and checking under *Properties > General > File System*. If the file system is NOT FAT32 format, format the USB-IDE hard disk drive using the FAT32 format.
5. If the USB-IDE hard disk drive is not partitioned, go to *Administrative Tools* in *Control Panel* and launch *Computer Management*. Open *Disk Management* in *Storage* and right click an unallocated region of the USB-IDE hard disk drive. Then, click *Create Partition*.
6. In the *Create Partition wizard*, click *Next* then *Primary Partition*, and follow the instructions on the screen. Make sure that the FAT32 is selected for the file system.

NOTE: The partition size should be less than 32GB because of Microsoft limitations.

After formatting is complete, the USB-IDE hard disk drive will be added to *My Computer*.

7. Connect the USB-IDE hard disk drive to the DVR.

Preparing USB-IDE hard disk drive in Windows 98

NOTE: Preparing a USB-IDE hard disk drive under Windows ME is almost identical to Windows 98.

1. Connect the USB-IDE hard disk drive to your computer using the USB Cable.
2. Turn on your computer. The *Add New Hardware wizard* window will appear.

3. Install the device driver for the USB backup device following the instructions provided with your USB hard disk drive.
4. If the USB-IDE hard disk drive is partitioned or contains data, it will show up in *My Computer* as a hard disk drive icon. Check the file system in *Properties > General > File System*. If the file system is NOT FAT32 format, format the USB-IDE hard disk drive with FAT32 format.
5. Run the FDISK utility by clicking *Start* then *RUN*. Type “fdisk” and click OK.
6. When the MS-DOS command prompt appears, type “Y” and hit the enter key.
7. In the FDISK Option menu, choose “5. *Change current fixed disk drive.*”
8. Choose the appropriate letter corresponding to the USB-IDE hard disk drive.
9. In the FDISK Option menu, choose “1. *Create DOS partition or Logical DOS Drive.*”
10. In the Create DOS Partition or Logical DOS Drive menu, choose “1. *Create Primary DOS Partition.*” And Type “Y” to use all available space and hit the enter key. Hit ESC to exit the screen after the USB-IDE hard disk drive partition is created.
11. Restart your computer and verify the newly created drive is in *My Computer*.
12. Right click the newly created hard disk drive icon and select “*Format*”.
13. In the Format Screen, select “*Full*” as the “*Format type*” and click “*Start*”.
14. After formatting is complete, connect the USB-IDE hard disk drive to the DVR.

Appendix B — Reviewing Backup Images

NOTE: It is suggested that the computer used for the Player program has at least an 800MHz Pentium III. If your CPU is slower than this, minibank files recorded at maximum speed with very high image quality will be played back slowly.

Disconnect the external USB-IDE hard disk drive from the DVR, and connect it to your PC. Double-clicking the target backup file starts the Player program.

NOTE: You do not need to install any special software on your personal computer to review the video. The backup file contains the Player program.

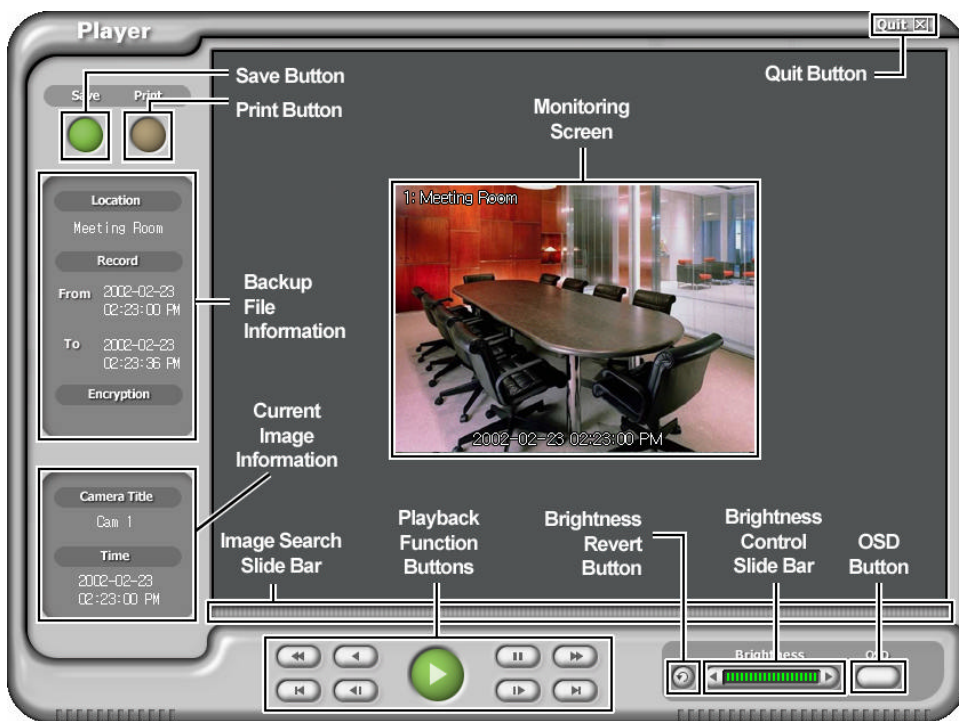

Figure 73 — Player screen.

Click the **Save** button to save the current image in a bitmap file format to the local hard disk drive or floppy disk.

Click the **Print** button to print the current image on the printer connected to your computer.

The **Backup File Information** window displays information regarding the backup file. **Location** displays the site description of the DVR where the backup was made. **Record** displays the time span of the video backup file. **Encryption** displays whether the backup file has been tampered with. **Normal** means the file has not been tampered with, **Wrong** means the system has detected tampering, and **Unknown** means the user cancelled the encryption check.

The **Current Image Information** window displays information about the current image. **Camera Title** displays the camera name of the current image, and **Time** displays the date and time the image was recorded.

The **Playback Function Buttons** include fast backward, backward, play, pause, fast forward, go to the first image, go to the previous image, go to the next image, and go to the last image buttons.

The **Image Search Slide Bar** displays the current playback position. The user can move to another image clicking the mouse and dragging along the slide bar.

The **Brightness Revert Button** reloads to the original image.

The **Brightness Control Slide Bar** adjusts the brightness of the backup images by clicking the mouse and dragging along the slider bar. Minute brightness change can be made by using the arrow buttons located at each end of the bar.

Clicking the **OSD (On-Screen Display) Button** switches the OSD option. The OSD information includes camera location and date/time.

The **Monitoring Screen** displays the backed up images. Clicking the right mouse button on the images switches the screen size between 320x240 and 640x480.

Clicking the **Quit** button exits the Player program.

Appendix C — Troubleshooting

Problem	Possible Solution
No Power	<ul style="list-style-type: none"> • Check power cord connections. • Confirm that there is power at the outlet.
No Live Video	<ul style="list-style-type: none"> • Check camera video cable and connections. • Check monitor video cable and connections. • Confirm that the camera has power. • Check camera lens settings.
Live Video Very Bright	If a cable is attached to the “Loop” connector, make certain it is connected to a properly terminated device.
Cannot Set Network Settings	Network capability not available on E Series models.
REC LED is Lit but DVR is not recording	Unit will only record video based on the parameters such as schedule and events defined during configuration. REC LED indicates the DVR is ready to record.
DVR has stopped recording	If hard disk drive is full, you will either need to delete video or set the DVR to the Overwrite Mode.
DVR displays an error message stating that the last recorded image date and time is later than the current date and time setting of the DVR.	The DVR will automatically reset the time and date of the unit, according to the time and date of the last recorded image. If this is not the correct time and date, reset the time and date manually. If the correct time and date is earlier than the last recorded image, any video with a later time and date will be lost when resetting the correct time and date.

Appendix D — Connector Pin Outs

I/O Connector Pin Outs

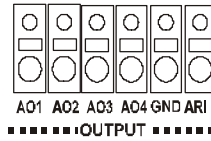
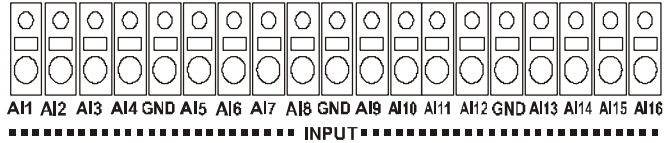

AI (1 to 16)	Alarm Inputs 1 to 16
GND	Chassis Ground (4 connectors)
AO (1 to 4)	Alarm Outputs 1 to 4
ARI	Alarm Reset In

RS485 Connector Pin Outs

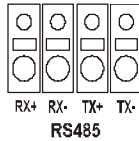

Master Unit	Slave Unit
RX+ ?	To ? TX+
RX- ?	To ? TX-
TX+ ?	To ? RX+
TX- ?	To ? RX-

RS232 Connector Pin Outs

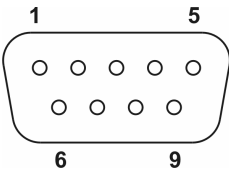

Pin 1	DCD (Data Carrier Detect)
Pin 2	RXD (Receive Data)
Pin 3	TXD (Transmit Data)
Pin 4	DTR (Data Terminal Ready)
Pin 5	GND (System Ground)
Pin 6	DSR (Data Set Ready)
Pin 7	RTS (Request To Send)
Pin 8	CTS (Clear To Send)
Pin 9	RI (Ring Indicator)

Appendix E — Map of Screens

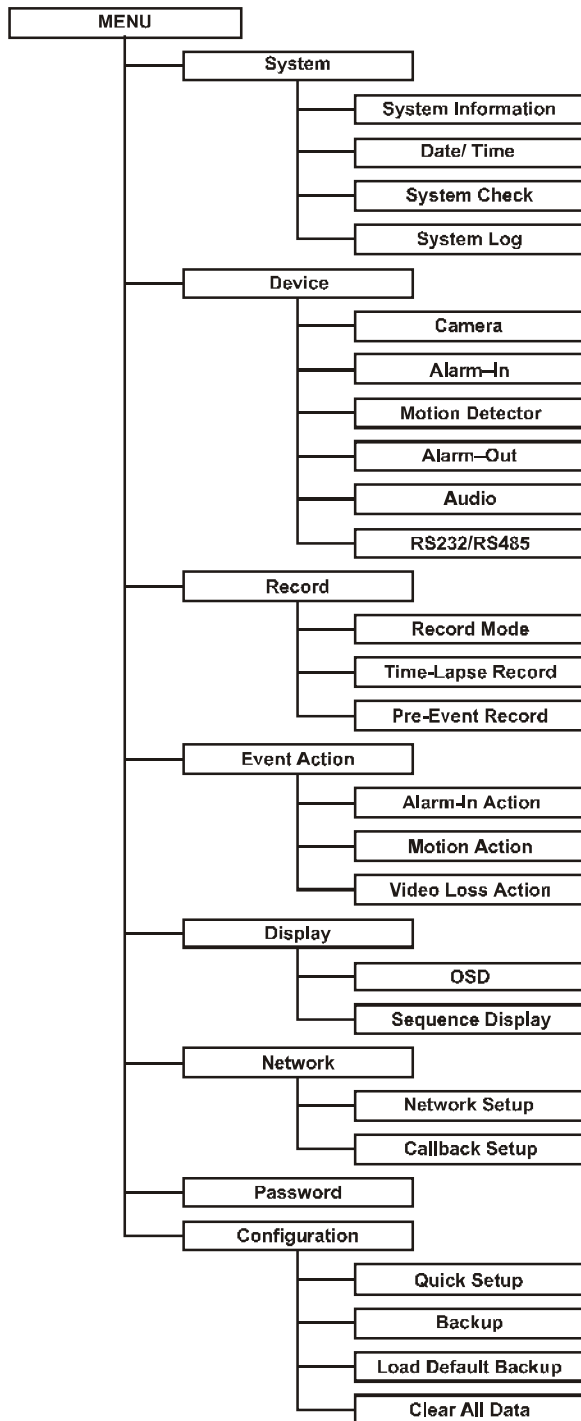

Appendix F – External Protocols

Message Format

```
<BOM><ID>:<Class>:<Code>[:Operands]:<Checksum>[EOM]
```

where:

Symbol	Value	Description
:	:	Field delimiter
<BOM>	@	Beginning of message (for command)
	<	Beginning of message (for reply)
<ID>	00~99	Device ID
<Class>	DR	Device Class ("DR" for DVR systems)
<Code>	AA~zz	Op-code (see below)
<Operands>		Optional operands defined for each operation
<Checksum> >	00~99	Checksum (sum of ASCII codes before checksum discarding overflow)
	*	No checksum
[EOM]	^J^M	End of message (optional: only for convenience of users using general terminal)

*All digits are in decimal format. Letters are case sensitive.

Control Flow

- Every transaction consists of one command and one reply.
- Characters transmitted before <BOM> are ignored.
- The format of operands is defined independently for each op-code.
- The <BOM> received before <Checksum> of previous message resets interpretation; i.e., discards the previous message. EXCEPTION: in the case of text input, none of the characters within the specified length has special interpretation.

Common Reply

Reply code	Reply data	Description
Ok		
Er	0000~9999	Error: return error number

Op Code

Function	Code	Operands	Reply	Reply data
Key Scan Code	KS	00~99 (model) :00~FF (key scan code): U/D/N ⁱ		

Error code

Error	Code
Unclassified error	0000
Unsupported command	0001

The number of front keys is fixed for each Model. A key scan code is allocated to a front key. U, D and N mean Up, Down and None respectively. None means there is no separate event for Key Up.

AHDR4

- 1. <ID> – the value set in the Unit ID field of System Information
- 2. <Class> – fixed as DR
- 3. <Code> – the only accepted command is KS
- 4. <Model> – fixed as 04
- 5. <Key Scan Code> – as follows

Key Scan Code	Front Key Button
40	UP
41	LEFT
42	ENTER
43	RIGHT
44	DOWN
45	ALARM
46	MENU
47	PTZ
48	SEARCH
49	PLAY
4A	RW
4B	FF
4C	STOP
4D	REC
58	CAMERA1
59	CAMERA2
5A	CAMERA3
5B	CAMERA4
5C	DISPLAY
5D	SEQUENCE
5E	FREEZE
5F	COUNTER

Example: When AHDR4 receives the following string, it acts as though the front “MENU” button is pressed.

```
@00:DR:KS:04:46:N:*
```

AHDR9

1. <ID> – the value set in the Unit ID field of System Information
2. <Class> – fixed as DR
3. <Code> – the only accepted command is KS
4. <Model> – fixed as 03
5. <Key Scan Code> – as follows

Key Scan Code	Front Key Button
40	UP
41	LEFT
42	ENTER
43	RIGHT
44	DOWN
45	ALARM
46	MENU
47	PTZ
48	SEARCH
49	PLAY
4A	RW
4B	FF
4C	STOP
4D	REC
4E	DISPLAY
4F	SEQUENCE
58	CAMERA9
5E	FREEZE
5F	COUNTER
60	CAMERA1
61	CAMERA2
62	CAMERA3
63	CAMERA4
64	CAMERA5
65	CAMERA6
66	CAMERA7
67	CAMERA8

Example: When AHDR9 receives the following string, it acts as though the front “MENU” button is pressed.

@00:DR:KS:03:46:N:*

AHDR16

1. <ID> – the value set in the Unit ID field of System Information
2. <Class> – fixed as DR
3. <Code> – the only accepted command is KS
4. <Model> – fixed as 02
5. <Key Scan Code> – as follows

Key Scan Code	Front Key Button
40	UP
41	LEFT
42	ENTER
43	RIGHT
44	DOWN
45	ALARM
46	MENU
47	PTZ
48	SEARCH
49	PLAY
4A	RW
4B	FF
4C	STOP
4D	REC
4E	DISPLAY
4F	SEQUENCE
56	CAMERA13
57	CAMERA14
58	CAMERA9
59	CAMERA10
5A	CAMERA11
5B	CAMERA12
5C	CAMERA15
5D	CAMERA16
5E	FREEZE
5F	COUNTER
60	CAMERA1
61	CAMERA2
62	CAMERA3
63	CAMERA4
64	CAMERA5
65	CAMERA6
66	CAMERA7
67	CAMERA8

Example: When AHDR16 receives the following string, it acts as though the front “MENU” button is pressed.

@00:DR:KS:02:46:N:*

Appendix G — Specifications

VIDEO	
Signal Format	NTSC or PAL (selector switch)
Video Input	Composite: 4, 9 or 16 looping inputs, 1 Vp-p, auto-terminating, 75 Ohms
Monitor Outputs	Composite: One, 1 Vp-p, 75 Ohms SVHS: One
Video Resolution	720x480 (NTSC), 720x576 (PAL)
Playback/Record Speed (images per second)	Simplex: 60ips (NTSC), 50ips (PAL) Duplex: 30ips (NTSC), 25ips (PAL)

INPUTS/OUTPUTS	
Alarm Input	4, 9 or 16 dry contact, NC/NO programmable, 4.3V threshold
Alarm Output	4 dry contact (open collector), 5mA@12V, 30mA@5V
Alarm Reset Input	1 dry contact, 4.3V threshold
Network Connectivity (Networkable Model only)	10/100 Mbps Ethernet RS-232 for external modem
Audio Input	One, "line in" or "mic" programmable
Audio Output	One, "line"

CONNECTORS	
Video Input	Composite: 4, 9 or 16 BNC
Video Loop	Composite: 4, 9 or 16 BNC
Monitor Output	Composite: 1 BNC SVHS: 1 Y/C
Audio In	RCA connector
Audio Out	RCA connector
Alarms	Terminal block
Ethernet Port	RJ-45
RS232 Serial Port	DB9 (P)
RS485 Serial Port	Four-connector terminal block
USB Port	USB connector

Specifications are subject to change without notice.

STORAGE	
Primary Storage	EIDE hard disk drive (up to 4)
Backup Storage	USB

GENERAL	
Dimensions (W x H x D)	16.9" x 3.5" x 14.4" (430mm x 88mm x 365mm)
Unit Weight	20.9 lbs. (9.45kg)
Shipping Weight	24.1 lbs. (10.95kg)
Shipping Dimensions (W x H x D)	21.5" x 11.2" x 19.7" (547mm x 285mm x 500mm)
Operating Temperature	41°F to 104°F (5°C to 40°C)
Operating Humidity	0% to 90%
Power	100 to 240 VAC, 1/2 A, 60/50Hz

APPROVALS	
FCC	FCC PART 15 Subpart B, Class A
CE	EMI: EN55022, 1998, Class A Safety: EN60950 Immunity: EN50130-4, 1998, Alarm Standard
UL	cUL60950

Specifications are subject to change without notice.



(Headquarters)

175 Eileen Way
Syosset, NY 11791
USA
1-516-921-6704
Customer Service:800-467-5875
Applications:877-653-0302
Technical Support:877-718-0746
Fax:516-921-0491
Website:
www.ademco.com/ademcovideo

ADEMCO International (Headquarters)

180 Michael Drive
Syosset, NY 11791
USA
1-516-921-6704

AUSTRALIA

ADEMCO Australia
Unit 5, Riverside Centre
24-28 River Road West
Parramatta, NSW 2150
Australia
61-2-8837-9300

ASIA/PACIFIC

ADEMCO Asia Pacific
Flat A&B, 7/F, CDW Building
388 Castle Peak Road
Tsuen Wan, N.T.
Hong Kong
852-2405-2323

LATIN AMERICA

ADEMCO International (Latin America)
9315 NW 112 Avenue
Miami, FL 33178
1-305-805-8188

ADEMCO Brasil
Rua Eng. Isaac Milder, 500
Sao Paulo, SP
Brasil
CEP: 05688-010
55-11-3758-6111

EUROPE

ADEMCO France
Parc Gutenberg
13, Voie La Cardon
91120, Palaiseau
France
33-1-69321090

ADEMCO Italia SpA
Viadella Resistenza, 53/59
20090 Buccinasco MI
Italy
39-02-457-179-1

ADEMCO Sontrix España
Vivero 528040
Madrid
Spain
34-91-533-4706

Security House
Amperestraat 41
1446 TR Purmerend
Netherlands
31-299-419-000

Video Controls Ltd.
Aston Fields Rd.
Whitehouse Ind. Est
Runcorn
UKWA73DL
44-928-754000