

User's Manual

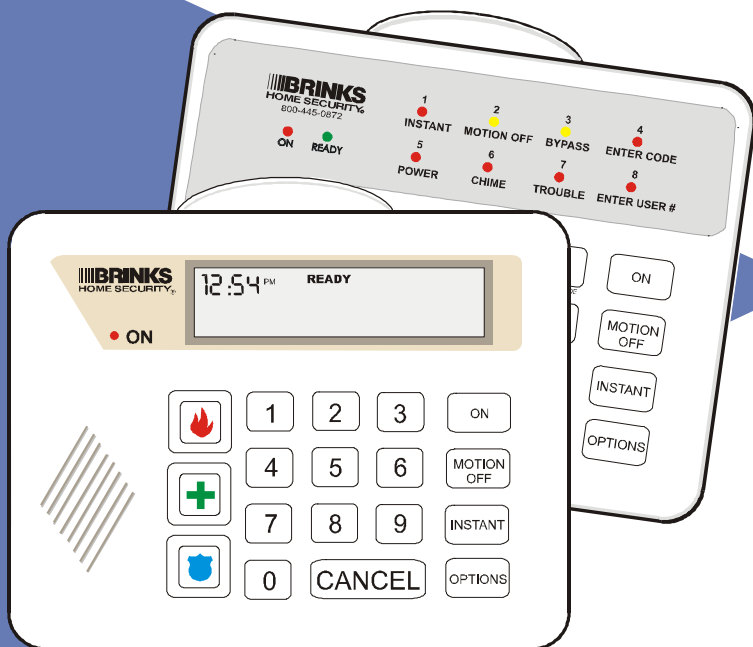

BHS-3000A

BRINKS
HOME SECURITY®

Consumer Information

FCC Notice

This equipment has been tested and found to comply with the limits for a Class B digital device, pursuant to Part 15 of the FCC Rules. These limits are designed to provide reasonable protection against harmful interference in a residential installation. This equipment generates, uses and can radiate radio frequency energy and, if not installed and used in accordance with the instructions, may cause harmful interference to radio communications. However, there is no guarantee that interference will not occur in a particular installation. If interference generated by this unit is suspected, call Brink's Customer Care at 1-800-445-0872.

If this equipment does cause harmful interference to radio or television reception, which can be determined by turning the equipment off and on, the user is encouraged to try to correct the interference by one or more of the following measures:

- Re-orient the radio/television antenna;
- Move the television or receiver away from the unit.
- Plug the unit and the TV/radio receiver into different outlets, i.e. not on the same circuit breaker.
- Contact Brinks Home Security or an experienced TV/Radio technician for additional suggestions.
- Review additional instructions on www.mybrinks.com.

This equipment complies with FCC Rules, Part 68.

On the outside of this equipment is a label that contains, among other information, the FCC Registration Number and Ringer Equivalence Number (REN) for this equipment. If requested, provide this information to your telephone company.

This equipment is equipped with a USOC RJ31X connector. This equipment is designed to be connected to the telephone network or premises wiring using a compatible modular jack (RJ31X) which is part 68 compliant.

The REN is useful to determine the quantity of devices you may connect to your telephone line and still have all of those devices ring when your number is called. In most, but not all areas, the sum of the REN's of all devices should not exceed five (5.0). To be certain of the number of devices you may connect to your line, as determined by the REN, you should call your local telephone company to determine the maximum REN for your calling area.

Should you experience trouble with the telephone lines, disconnect the equipment from the line to determine the source of the trouble. If it is determined that the equipment is malfunctioning, discontinue its use until the malfunction has been corrected. Any repairs or alterations made by the user to this equipment, or equipment malfunctions, may give the telephone company cause to request the user to disconnect the equipment. If you experience trouble with this equipment, please contact Brink's Home Security Customer Care at 1-800-445-0872 for information on obtaining service or repairs, or visit www.mybrinks.com and select the Frequently Asked Questions link.

Should this equipment causes harm to the telephone network, the telephone company may temporarily discontinue your service. If possible, they will provide you with advance notice. Otherwise they will notify you as soon as possible. The telephone company will also advise you of changes in its facilities, equipment, operations or procedures which could affect the operation of your equipment, allowing you the opportunity to maintain uninterrupted service. You will also be advised of your right to file a complaint with the FCC.

This equipment must not be used on party lines or coin-operated phone lines.

Industry Canada

NOTICE: The Industry Canada label identifies certified equipment. This certification means that the equipment meets certain telecommunications network protective, operational and safety requirements as prescribed in the appropriate Terminal Equipment Technical Requirements documents. The Department does not guarantee the equipment will operate to the user's satisfaction.

Before installing this equipment, users should ensure that it is permissible to be connected to the facilities of the local telecommunications company. The equipment must be installed using an acceptable method of connection.

The customer should be aware that compliance with the above conditions may not prevent the degradation of service in some situations.

Repairs to certified equipment should be coordinated by a representative designated by the supplier. Any repairs or alterations made by the user to this equipment, or equipment malfunctions may give the telecommunications company cause to request the user to disconnect the equipment.

Users should ensure for their own protection that the electrical ground connections of the power utility, telephone lines and internal metallic water pipe system, if present, are connected together. This precaution may be particularly important in rural areas.

Caution: Users should not attempt to make such connections themselves, but should contact the appropriate electric inspection authority, or electrician, as appropriate.

NOTICE: The Ringer Equivalence Number (REN) assigned to each terminal device provides an indication of the maximum number of terminals allowed to be connected to a telephone interface. The termination on an interface may consist of any combination of devices subject only to the requirement that the sum of the Ringer Equivalence Numbers of all the devices does not exceed 5.

This Class B digital apparatus Complies with Canadian ICES-003.
Cet appareil numérique de la classe B est conforme à la norme NMB-003 du Canada.

Visit www.mybrinks.com or contact Brink's Customer Care at 1-800-445-0872 for information on obtaining service or repairs.

Certification Number: 1140 10954A.

Table of Contents

Consumer Information	ii
FCC Notice	ii
Industry Canada	iii
Welcome	2
How to Avoid False Alarms	3
The Brink's Home Security System	4
Standard Equipment.....	4
Optional Equipment.....	6
Optional Features	7
The Parts of the Keypad	2
Status Display (Standard Keypad).....	4
Message Window (Premium Keypad)	4
Emergency Keys.....	5
Using The Keypad	6
User Codes	7
Entering and Exiting	7
Designated Doors.....	7
Entry Delay	7
Exit Delay.....	7
Turning the System On	8
The Four On Modes	8
Turning the System On in Normal Mode	9
Turning the System On with Motions Turned Off Mode.....	9
Turning the System On with Motions Turned Off / Instant Mode.....	10
Turning the System On in Instant Mode	10
Turning the System On When It Is Not Ready.....	11
Turning the System Off	13
Turning the System Off When No Alarms Are In Progress.....	13
Turning the System Off and Canceling an Alarm.....	13
Turning the System Off Without Canceling an Alarm.....	14
What to Do in an Actual Emergency.....	14
Turning the System Off After an Alarm in Your Absence.....	15
System Options	16
How to Bypass a Zone	16
How to Turn the Door Chime On or Off	17
How to View Alarm Memory.....	17
How to Add an Auxiliary Code	19
How to Delete an Auxiliary Code	21
System Testing	22
Siren and Transmission Test	22
Testing All Burglary Sensors.....	23
Testing the Smoke Detector.....	24
Testing the Doors and Windows Only	24
Testing With Not Ready Zones	26

Trouble Messages	27
Standard Keypad	27
Premium Keypad	27
No AC Power Indication	28
Low Battery Indication	29
Communication Problem Indication	30
Line Cut Indication (Optional Feature)	31
Upload/Download Failure	31
Zone Trouble Indication.....	32
Component Failure	32
Call Brink's Indication	32
Siren Failure Indication.....	32
Keypad Not Working (Speaker Clicks)	32
If You Trigger an Alarm while Cleaning the Detector	33
Service the Detector Every Two Years	33
Setting the Clock	34
Emergency Evacuation Plans	34
Questions and Answers	36
General Use of the System	36
Codes and Code Words	37
Alarms and Emergencies	38
Emergency Contacts	38
Financial Questions	39
Repairs and Upgrades.....	41
Additional Questions?.....	41
Warranty Information	41
Important Notices	42

Welcome

Thank you for choosing Brink's Home Security®. We appreciate your business.

To get the most from the easy-to-use Brink's Home Security System, please take the time to read this manual. It describes the components of the system, and tells you how to use the keypad. It also tells you what to do in the event of an alarm. Also, be sure to read your Customer Emergency Information Schedule so that you will have a clear understanding of Brink's procedures if you should have an alarm.

If you have any questions about the security system, visit www.mybrinks.com or call Brink's Customer Care at 1-800-445-0872. Customer Care is ready to help you 24 hours a day, seven days a week.



How to Avoid False Alarms

Numerous false alarms can affect the quality of your monitoring service. They can also result in fines from your local municipality. To avoid false alarms, follow these simple tips:

1. Be sure that everyone in your house knows how to use the alarm system. Everyone should know a user code and the code word. You can use the interactive keypad at www.mybrinks.com to practice turning the system on and off without causing an alarm.
2. If you cause an alarm accidentally, cancel it by entering your user code and pressing the CANCEL key. (See page 13.)
3. Test the system every week, following the instructions beginning on page 22. If you discover any problems, promptly notify Brink's Customer Care at 1-800-445-0872.
4. If there was an alarm on the system, and you do not know why it happened, contact Brink's Customer Care immediately. You may also review the system's alarm history at www.mybrinks.com.
5. If you are going to do any kind of work at your home that will create a large amount of dust, (such as fumigation), completely cover the system's motion detectors and smoke/heat detectors. Be sure to remove the covers when you are finished.
6. If you know that the motion detector is causing false alarms, you can still turn the system on, while the motion detector is turned off. See the instructions on page 9 (Turning the System On with Motions Turned Off Mode). Promptly notify Brink's Customer Care to correct the problem.
7. If you get an indoor pet after the system is installed, contact Brink's Customer Care. The system's motion detector may need to be adjusted so that your pet does not cause a false alarm.
8. Motion detectors can detect the movement of balloons, plants, curtains, and other common household objects. Be sure that air currents cannot move these items into the area covered by the motion detector.
9. Notify Brink's before you sell or rent out your home, so that we can teach the new residents how to use the system. Visit our website

at www.mybrinks.com to get more information about our Customer Move Program.

10. Take care when cooking or lighting a fire in the fireplace. Excessive smoke from these activities can cause false alarms.

The Brink's Home Security System

Standard Equipment



Master
Control Panel

The master control panel is housed in a metal box. It is mounted in an out-of-the-way location, such as a closet. The master control panel processes the information sent to it by the system's sensors and keypad. It also contains a battery that allows the system to operate during a power failure. When an alarm occurs, the master control panel sends a message over the telephone line to the Brink's Monitoring Center.

Do not open the master control panel unless a Brink's representative instructs you to do so.



Keypad
(Premium Style
Shown)

The keypad is mounted on the wall, near an entry/exit door. You can use it to turn the system on and off, and to change other system options. Keypads come in Premium and Standard styles (see pages 2 and 3.)

You can also use the keypad's emergency panic buttons to signal a fire, medical, or police emergency. (See page 5 for more information or review the Keypad Functions information at www.mybrinks.com.)

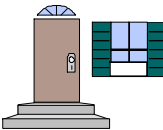

Door/ Window
Sensors

One sensor is placed in or on the frame and body of each door or window that is protected. If the door or window is opened while the system is on, an alarm sounds. An alarm signal is sent to the Brink's Monitoring Center.

Standard Equipment



Motion Detector

This sensor is mounted on the wall, inside your home. The sensor can detect when someone is moving within its field of view. If the system is on at the time a person is detected, the system sends an alarm signal to the Brink's Monitoring Center.



Siren

The siren is a small plastic box, mounted inside your home. When an alarm occurs, the siren sounds a warning, designed to frighten off intruders. The siren may also sound when you use some of the system's special features.

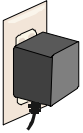

Power Transformer

The power transformer is plugged into an outlet near the master control panel. It provides electrical power to the system.

If you should notice that the transformer is unplugged, plug it back in immediately.

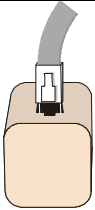

Telephone Jack

This device connects the security system to the telephone line in your home. It is located near or inside the master control panel. This makes it possible for the system to send alarm signals over the telephone lines to the Brink's Monitoring Center.

Do not remove the dialer cable from the jack unless a Brink's representative or this manual instructs you to do so.



Yard Sign and Window Stickers

The highly visible sign and stickers warn potential intruders that your home is protected by a Brink's Home Security system. You will be provided with one sign and several stickers.

Optional Equipment



Smoke/Heat
Detector

This device detects smoke and dangerously high temperatures. It is mounted in a central location of the house, on the ceiling. Smoke/heat detectors are not available for commercial installations.



Heat Sensor

This device detects when the temperature near the sensor is dangerously high. It is mounted in a central location of the house, on the ceiling. Heat sensors are not available for commercial installations.



Glass Breakage
Detector

This small detector is mounted near any large expanse of glass (windows or doors) in your home. It identifies the sound of breaking glass.



SmartKey

The SmartKey™ is a small remote-control device for the security system. The four buttons on the device can be used to turn the system on and off, and to do other specialized functions, like trigger an emergency alarm.



Telephone
Control Module

The optional Telephone Control Module allows you to control the security system from any touch-tone telephone, whether you are at home or across the country. You can check the system's status while on vacation, or trigger an emergency alarm from your bedroom. The Telephone Control Module is also a helpful feature for visually-impaired users who may have difficulty using a traditional keypad.

Optional Features

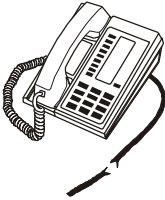

Line Cut

If your telephone line is cut, the optional line cut feature notifies you. If the system is on, the siren sounds. If the system is off, the keypad beeps and displays a trouble message. Because a line cut results in a loss of telephone service, this event is not reported to the Brink's Monitoring Center.



Pager/Latchkey

The optional pager/latchkey feature notifies you that your children have arrived home safely when you are away. When your child turns the system on or off, you receive a page on your pager. You can also receive pages for other system events, like alarms or power loss.

For information about any of these products or services, visit www.mybrinks.com or call Brink's Customer Care at 1-800-445-0872. Customer Care is ready to help you 24 hours a day, seven days a week.

The Parts of the Keypad

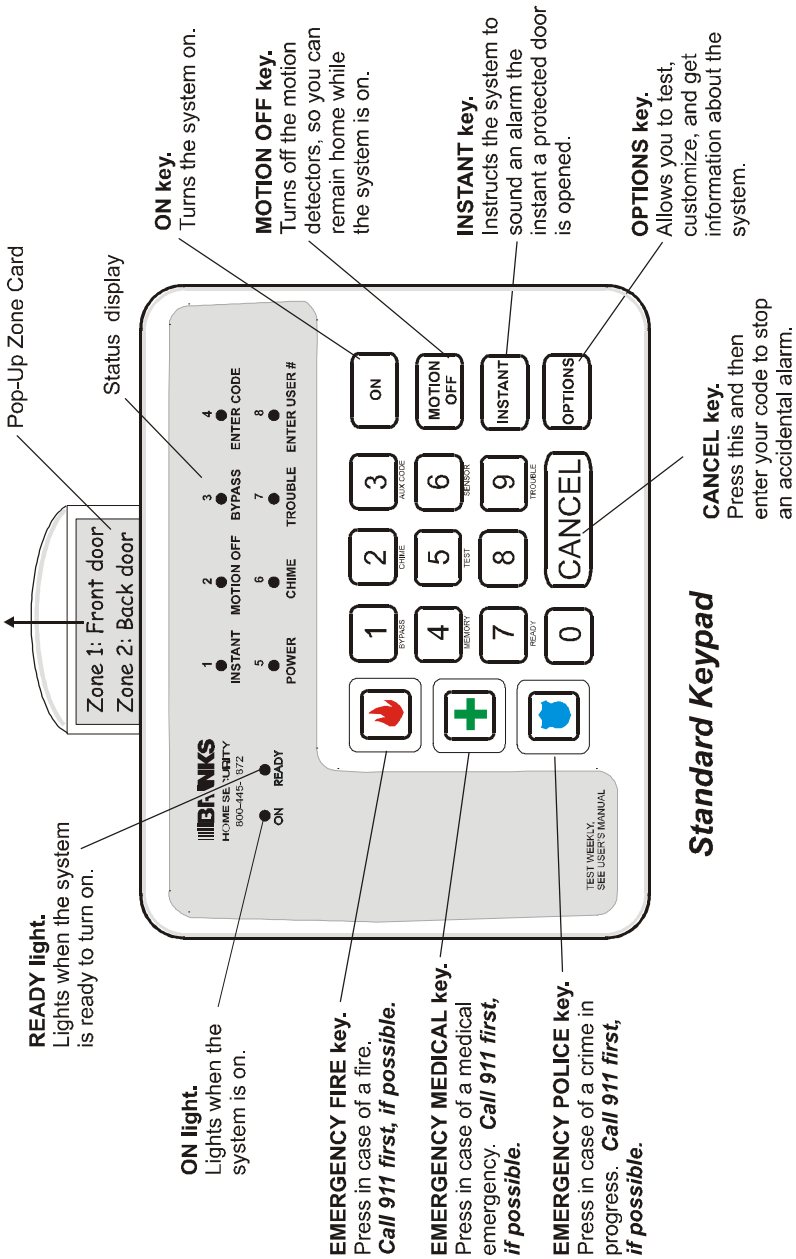

Standard Keypad

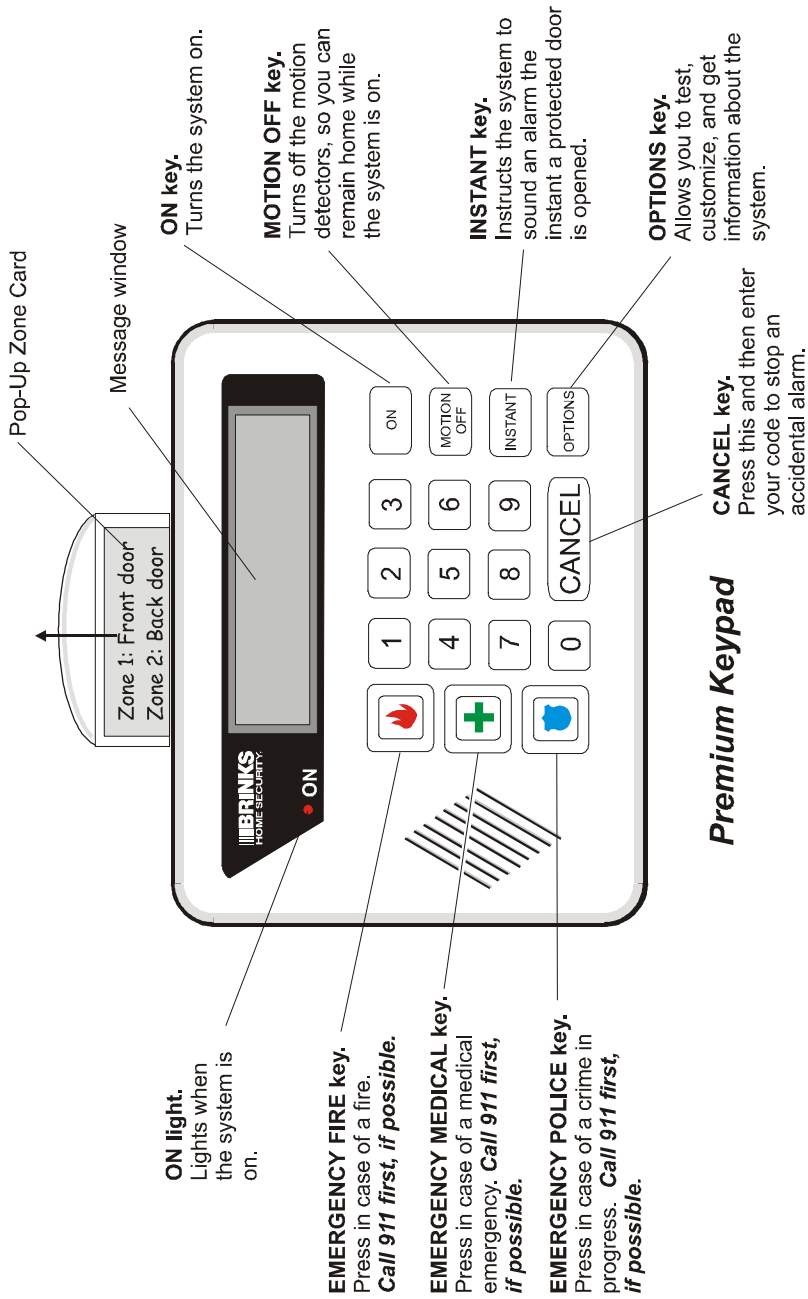

Premium Keypad

Status Display (Standard Keypad)

The illustration below shows the functions of the keypad's lights.

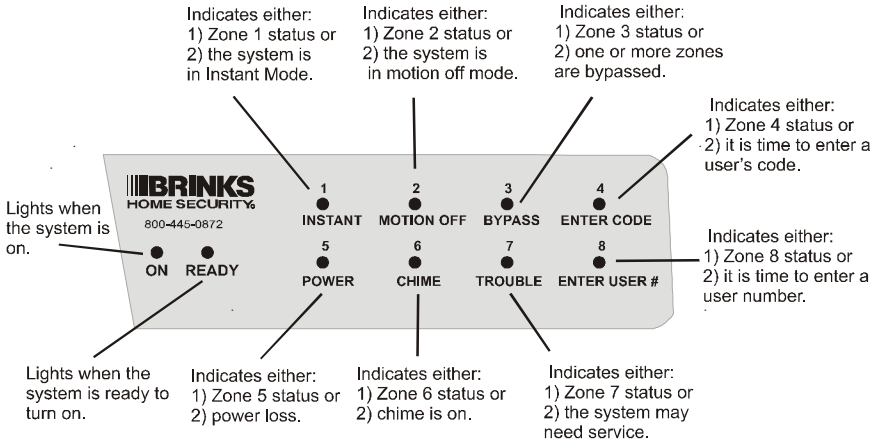

Message Window (Premium Keypad)

The Premium Keypad communicates with you by lighting the words and phrases in the message window. The words that make up the message may be on different lines, or separated by other words.

For example, while you are changing an auxiliary user code, you will see the following message window:





The words "ENTER" and "NEW CODE" are lit. This means that you should enter the new user code.

Emergency Keys

If you are home when a police, medical, or fire emergency arises, you can alert the Brink's Monitoring Center of your situation with a single press of an emergency key. The system does not need to be on. (Not all emergency buttons are available to all commercial customers.)

The table shows what purpose each key serves, and what happens when it is pressed. (Depending upon how the system is programmed, you may need to press the emergency key twice within three seconds to signal an emergency alarm.)

Emergency	Press	This happens
Fire		The siren sounds and a signal is sent to the Brink's Monitoring Center. Brink's calls the fire department, and then calls you to verify the alarm. (This procedure may vary in some jurisdictions.)
Medical		The keypad beeps and a signal is sent to the Brink's Monitoring Center. Brink's calls you to verify the alarm. If for any reason you do not answer that call, Brink's calls emergency personnel.
Police		The siren sounds and a signal is sent to the Brink's Monitoring Center. Brink's calls you to verify the alarm. If for any reason you do not answer that call, Brink's calls emergency personnel.

CALL 911 FIRST

If your community provides 911 Emergency service, and you are able to reach a telephone during the emergency, Brink's recommends that you call 911 before pressing the emergency key. This gives you the fastest access to emergency services.

If you press an emergency key accidentally, cancel the alarm by pressing the CANCEL key, and entering your user code. (For more information about canceling alarms, see page 13, or review the Reduce False Alarms information at www.mybrinks.com.)



Using The Keypad

The Brink's Home Security system in your home may have a Standard Keypad, or a Premium Keypad. Both types of keypads can be used to turn the system on or off, or to test or customize it. For some procedures, the keypads' commands are slightly different. In those cases, this manual contains two sets of instructions, like those shown below. If you are using a Standard Keypad, follow the instructions on the left. If you are using a Premium Keypad, follow the instructions on the right.

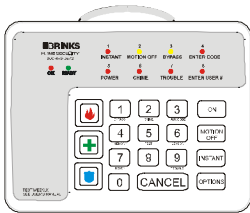
If the keypad looks like this:



Follow the instructions for the Standard Keypad

Standard Keypad	
 <p>OPTIONS</p>	<p>1. Press the OPTIONS key.</p>
 <p>7</p>	<p>2. Press the 7 key.</p>

If the keypad looks like this:

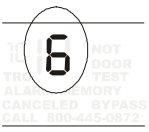
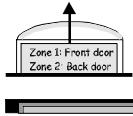

Follow the instructions for the Premium Keypad

Premium Keypad	
 <p>NOT DOOR TEST TRIP MEMORY ALARM MEMORY CANCELED BYPASS CALL 800-445-0877</p>	<p>1. Observe the number displayed in the message window. This is the zone that is not ready. (There may be more than one.)</p>
	<p>2. Refer to the Pop-Up Zone Card to verify the location of the zone.</p>

User Codes

When the system is installed, you select a code number to turn the system on and off. This is your **master user code**, and it may be three or four digits long. To change this code, contact Brink's Customer Care at 1-800-445-0872.

You can create a separate auxiliary user code for anyone who needs access to your home. See page 19 for more information. You can change or delete the auxiliary code whenever you like.

If you have questions about the system's user codes, visit our website or contact Brink's Customer Care.

Entering and Exiting

Designated Doors

The designated entry/exit doors are those doors that you must use to enter and leave your home while the system is on. These doors may be equipped with the door sensors described on page 4. If you use a different door to enter your home, an alarm may sound.

Entry Delay

When you enter your home while the security system is on, the keypad beeps. This beeping reminds you to turn the system off. You must enter your user code before the beeping stops. In most systems, that delay is 40 seconds long. If you do not enter your code before the delay ends, an alarm is triggered.

Exit Delay

When you turn the system on in normal mode, you must exit the building and close the door before the exit delay ends. For most systems, the exit delay is 80 seconds; however, that number may vary if local agency or regulator restrictions apply. Once that delay has ended, you will trigger an alarm if you open a protected door or window, or move past a motion detector.

Note: The length of the system's entry and exit delays can be adjusted (within certain limits). If you find it difficult to enter or exit your home

before the delay ends, contact Brink's Customer Care at 1-800-445-0872 to have it changed.

Turning the System On

The Four On Modes

You can arm the Brink's Home Security system in four different ways:

- 1) normal mode;
- 2) motion off;
- 3) motions off with delay doors instant; and
- 4) delay doors instant.

The illustration below helps you choose which mode to use.

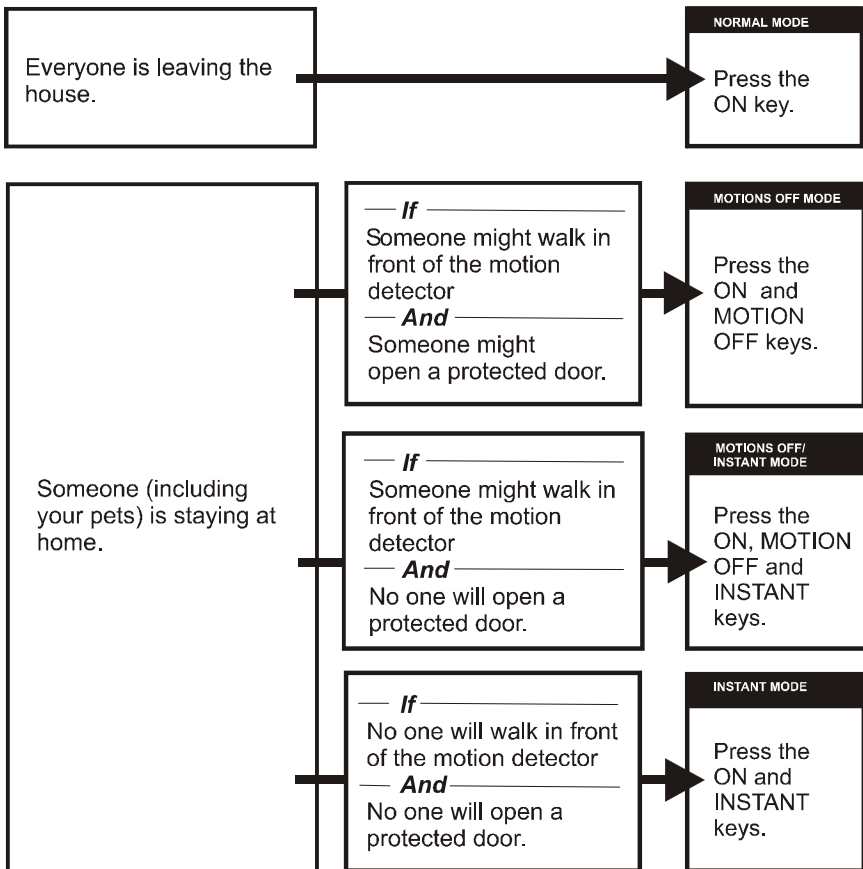

Turning the System On in Normal Mode

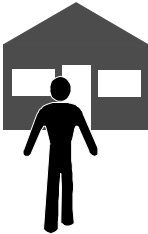

1. Close all of the doors and windows and make sure that the message window reads **READY** or the **READY** light is lit. (If not, see page 11.)

2. Press the **ON** key.

The **ON** light begins to blink, telling you that the system is on and that the exit delay has begun. The Premium Keypad displays the number of seconds left in the exit delay.

3. Exit promptly. You must leave the building before the delay ends. The standard delay is 80 seconds.

If the **ON** light stops blinking and is steadily lit, the exit delay has ended. If you open a door now, you will cause an alarm. Turn the system off by entering your user code, then start over.

Turning the System On with Motions Turned Off Mode



1. Close all of the doors and windows and make sure that the message window reads **READY** or the **READY** light is lit. (If not, see page 11.)

2. Press the **ON** key.

3. Press the **MOTION OFF** key. (You must press the **MOTION OFF** key no more than 20 seconds after you press the **ON** key.)

The **ON** light blinks. The Premium Keypad reads **ON**, **MOTION OFF**. The Standard Keypad's **MOTION OFF** and **ON** lights are lit.

Turning the System On with Motions Turned Off / Instant Mode



1. Close all of the doors and windows and make sure that the message window reads READY or the READY light is lit. (If not, see page 11.)

2. Press the ON key.

3. Press the MOTION OFF key.

4. Press the INSTANT key.

The ON light turns on. The Premium Keypad reads ON, MOTION OFF, and INSTANT. The Standard Keypad's ON, MOTION OFF and INSTANT lights are lit.

Do not leave the building, or open any protected windows without first turning the system off.

Turning the System On in Instant Mode



1. Close all of the doors and windows and make sure that the message window reads READY or the READY light is lit. (If not, see page 11.)

2. Press the ON key.

3. Press the INSTANT key.

The ON light turns on. The Premium Keypad reads ALL ON, INSTANT. The INSTANT light of the Standard Keypad turns on.







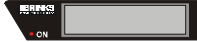

Do not leave the building, open any protected windows, or move in front of the motion detector without first turning the system off.

Turning the System On When It Is Not Ready

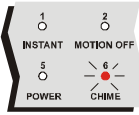
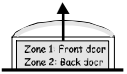
If the system is not ready to turn on, you get a not ready message. This message could mean, for example, that one of the protected windows in your house is open. If you have a Standard Keypad, the READY light is off. If you have a Premium Keypad, the message window reads NOT READY.

If you press the ON key when the system is not ready to turn on, the keypad sounds an error tone and the system does not turn on.

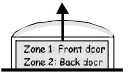
To make the system ready to arm and it on, do the following:

	Standard Keypad		Premium Keypad
     	<ol style="list-style-type: none"> 1. Press the OPTIONS key. 2. Press the 7 key. 3. Observe which zone light blinks for the next five seconds. This is the zone that needs to be corrected before the system will turn on. (There may be more than one.) 4. Refer to the Pop-Up Zone Card to verify the zone's location. 5. If the zone is a door or window, make sure that it is securely closed. 6. If the READY light illuminates, turn the system on. 	   	<ol style="list-style-type: none"> 1. Observe the number displayed in the message window. This is the zone that needs to be corrected before the system will turn on. (There may be more than one, if so, the numbers are shown one at a time.) 2. Refer to the Pop-Up Zone Card to verify the zone's location. 3. If the zone is a door or window, make sure that it is securely closed. 4. If the message window reads READY, turn the system on.

(continued)



Standard Keypad



1-800-445-0872

OPTIONS

1

BYPASS

8

ZONE
NUMBER

ON

7. If the READY light does not turn on, see the Frequently Asked Questions information at www.mybrinks.com or call Customer Care at 1-800-445-0872 for further assistance in correcting the not-ready condition.

8. To turn the system on, you must first turn off the zone that is not ready to arm. Press the OPTIONS key.

9. Press the 1 key.

10. Enter the number of the not-ready zone, the number of the illuminated light you observed in Step 1.

CAUTION: If you bypass a zone, it will not be protected.

The keypad beeps. The READY and BYPASS lights turn on.

11. Turn the system on.



Premium Keypad



1-800-445-0872

OPTIONS

BYPASS
ENTER
ZONE

8

ZONE
NUMBER

ON

5. If the message window reads NOT READY, see the Frequently Asked Questions information at www.mybrinks.com or call Customer Care at 1-800-445-0872 for further assistance in correcting the not-ready condition.

6. To turn the system on, you must first turn off the zone that is not ready to arm. Press the OPTIONS key until the message window reads: BYPASS, ENTER ZONE #.

7. Enter the number of the not-ready zone, the same number that appeared in the message window.

CAUTION: If you bypass a zone, it will not be protected.

The keypad beeps. The message window reads READY, BYPASS and the number of the bypassed zone is momentarily displayed.

8. Turn the system on.

Turning the System Off

Turning the System Off When No Alarms Are In Progress



1. Enter through a designated entry door.

The keypad sounds a tone to remind you to turn the system off. The ON light blinks.

2. Turn the system off by entering your code.

To prevent an alarm, you must enter your code before the entry delay ends. The standard delay is 40 seconds.

The keypad beeps. Once the system is off, the ON light goes out.

Turning the System Off and Canceling an Alarm

Follow these instructions if you caused an alarm accidentally.



1. Enter through a designated entry door.

The siren is sounding and the ON light blinks. The Premium Keypad's message window reads ALARM. The Standard Keypad's ON light blinks.

2. Enter your user code.

The keypad beeps. The Premium Keypad's message window reads ALARM MEMORY.

3. Press the CANCEL key. (You must press the CANCEL key within 20 seconds of entering your code.)



You will **not** receive a call from Brink's. The Premium Keypad's message window reads ALARM CANCELED.

Note: If you press the CANCEL key **before** entering your code, the result is the same.

Turning the System Off Without Canceling an Alarm

Follow these instructions if you wish to turn off the system and report an alarm to Brink's.



1. Enter the building through a designated entry door.

The Premium Keypad's message window reads ALARM. The siren is sounding and the ON light is lit.

2. Enter your user code.

The keypad beeps. Wait for Brink's to call. Be prepared to give the Brink's operator your code word.

Do not use the telephone if you intend to cancel the alarm. If your telephone line is busy, Brink's may dispatch emergency personnel to your home, which could result in a false alarm fine.

What to Do in an Actual Emergency

If the security system is sounding an alarm, and there is an actual emergency in progress, do the following:



1. Leave the system on. If the emergency is a fire, quickly notify the building's occupants and safely evacuate the building.
2. Do not use the telephone, except to call 911. If you do, Brink's personnel may not be able to contact you. If you are trying to make a telephone call while another alarm is triggered, the system will disconnect your call to send the alarm signal. If this continues, you may need to turn the system off to use the telephone.
3. If this is a medical or police emergency, wait for Brink's to call. Explain the emergency to the operator. If you do not answer the telephone, Brink's will try to contact the appropriate emergency agency, unless you have given other instructions.

Turning the System Off After an Alarm in Your Absence

Follow these instructions if there was an alarm at your house while you were away and the sirens are no longer sounding.

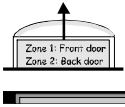
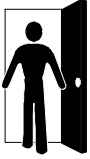

1. Enter the building through a designated entry door.

The ON light blinks. The sirens and speakers are silent. The Premium Keypad shows the numbers of the zones in alarm and its message window reads ALARM.

2. Enter your user code to turn the system off.

The keypad beeps for one second. The keypad shows the numbers of the zones that were in alarm. The Premium Keypad reads ALARM MEMORY.

3. Refer to the Pop-Up Zone Card to verify the location of the zones that were in alarm.

4. To silence the keypad's beeping and clear Alarm Memory, press the CANCEL key.

5. If you do not know what caused the alarm, review the system's alarm history at www.mybrinks.com or call Brink's Customer Care at 1-800-445-0872.

System Options

The system has five options:





- 1) bypass;
- 2) door chime;
- 3) auxiliary codes;
- 4) alarm memory; and
- 5) test.



This section describes each of these five options.

How to Bypass a Zone

When you bypass a zone, the system ignores it. Use this whenever you want to turn the system on, but leave a particular sensor off. The bypass is automatically canceled when you turn the system off.





To bypass a zone, do the following:



	Standard Keypad
	1. Press the OPTIONS key.
 BYPASS	2. Press the 1 key.
	3. Enter the number of the zone you wish to bypass. The keypad beeps. The READY and the BYPASS lights turn on.

	Premium Keypad
 Bypass ENTER ZONE #	1. Press the OPTIONS key until the message window reads: BYPASS, ENTER ZONE #.
	2. Enter the number of the zone you wish to bypass. The keypad beeps. The message window reads READY, BYPASS. The number of the bypassed zone lights momentarily.

How to Turn the Door Chime On or Off

When you turn the door chime on, the keypad beeps if a protected door or window is opened while the system is turned off. To turn the chime on or off, do the following:



 Standard Keypad	
  CHIME	<ol style="list-style-type: none"> 1. Press the OPTIONS key. 2. Press the 2 key. The ENTER CODE light blinks. 3. Enter your code. The keypad beeps. The READY and the CHIME light turns on while the chime feature is on.
 CODE	



 Premium Keypad	
 DOOR CHIME ENTER CODE	<ol style="list-style-type: none"> 1. Press the OPTIONS key until the message window reads: DOOR CHIME, ENTER CODE. 2. Enter your code. The keypad beeps. The message window reads READY, DOOR CHIME.
 CODE	

Note: If you turn the door chime on and the keypad does not beep, the chime feature may have been turned off at installation. Call Customer Care for assistance.

How to View Alarm Memory

You can use alarm memory to determine which zones were in alarm.

 Standard Keypad	
  MEMORY	<ol style="list-style-type: none"> 1. Press the OPTIONS key. 2. Press the 4 key. The ENTER CODE light blinks.

 Premium Keypad	
 ALARM MEMORY ENTER CODE	<ol style="list-style-type: none"> 1. Press the OPTIONS key until the message window reads: ALARM MEMORY, ENTER CODE.







<table border="1"><tr><td>1</td><td>2</td><td>3</td></tr></table> CODE	1	2	3	3. Enter your user code. The keypad beeps. The lights of the zones that were last in alarm blink.
1	2	3		







<table border="1"><tr><td>1</td><td>2</td><td>3</td></tr></table> CODE	1	2	3	2. Enter your user code. The keypad beeps. The message window shows which zones were in alarm.
1	2	3		

How to Add an Auxiliary Code

You can assign an auxiliary user code to the members of your family, or to people who need temporary access to your home. Housekeepers, guests, and housesitters can all be given auxiliary codes. You can assign as many as 91 codes, but for your security, you should limit the number of auxiliary codes you assign, and delete any codes that are not in use.

To assign an auxiliary code, do the following:







	Standard Keypad
	1. Press the OPTIONS key.
 AUX CODE	2. Press the 3 key. The ENTER CODE light blinks.
 MASTER CODE	3. Enter the master user code. The keypad beeps. The ENTER USER # light blinks.
	4. Enter the number of the user to whom you want to assign a code (1 to 91). The keypad beeps. The ENTER CODE light blinks.
	5. Enter the new code. The keypad beeps.
	6. Test the new code by turning the system on, then using the code to turn the system off.







	Premium Keypad
 AUXILIARY CODES ENTER MASTER CODE	1. Press the OPTIONS key until the message window reads: AUXILIARY CODES, ENTER MASTER CODE.
 MASTER CODE	2. Enter the master user code. The keypad beeps. The message window reads: ENTER USER #.
	3. Enter the number of the user to whom you want to assign a code (1 to 91). The keypad beeps. The message window reads: ENTER NEW CODE.
	4. Enter the new code. The keypad beeps.
	5. Test the new code by turning the system on, then using the code to turn the system off.



How to Delete an Auxiliary Code

If you wish to delete an auxiliary user code, do the following:

	Standard Keypad
	1. Press the OPTIONS key.
 AUX CODE	2. Press the 3 key. The ENTER CODE light blinks.
 MASTER CODE	3. Enter the master user code. The keypad beeps. The ENTER USER # light blinks.
 USER NUMBER	4. Enter the number of the user whose code you wish to delete. The keypad beeps. The ENTER CODE light blinks.
	5. Do not enter the user's code. Instead, press the CANCEL key. The keypad beeps.
	6. Test that the code has been deleted by attempting to turn the system on and off using the deleted code.

	Premium Keypad
 AUXILIARY CODES ENTER MASTER CODE	1. Press the OPTIONS key until the message window reads: AUXILIARY CODES, ENTER MASTER CODE.
 MASTER CODE	2. Enter the master user code. The keypad beeps. The message window reads: ENTER USER #.
 USER NUMBER	3. Enter the number of the user whose code you wish to delete. The keypad beeps. The window reads: ENTER NEW CODE.
	4. Do not enter the user's code. Instead, press the CANCEL key. The keypad beeps.
	5. Test that the code has been deleted by attempting to turn the system on and off, using the deleted code.

System Testing

You can test the components of the system—the sirens, the telephone hook-up, and the sensors—without causing a false alarm. This section describes how you can be sure that the system is functioning properly.





Important Notice: Test Weekly





Your Protective Service Agreement requires you to conduct these tests every week.

Siren and Transmission Test

This test helps to ensure that the system's siren is working properly, and that the system is able to send an alarm signal to the Brink's Monitoring Center. You will not receive a call from Brink's.













To test the system's siren and transmission, do the following:

	Standard Keypad
	1. Press the OPTIONS key.
 TEST	2. Press the 5 key. The ENTER CODE light blinks.
 CODE	3. Enter your code. A test signal is sent to Brink's. If it is received, the siren sounds briefly. The keypad may also beep. All zone lights blink.
 1-800-445-0872	4. If you do not hear the beep or blast, and the TROUBLE light turns on, the test failed. Call 1-800-445-0872.



	Premium Keypad
	1. Press the OPTIONS key until the message window reads: TEST, ENTER CODE.
TEST, ENTER CODE	
 CODE	2. Enter your code. The display reads: TEST. A test signal is sent to Brink's. If it is received, the siren sounds briefly. The keypad may also beep.
 1-800-445-0872	3. If you do not hear the beep or blast, and the keypad message window reads CP TROUBLE, the test failed. Call 1-800-445-0872.

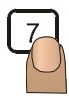

Testing All Burglary Sensors

This test helps to ensure that the system's burglary sensors are working properly. **No alarm signal is sent to the Brink's Monitoring Center.**

	Standard Keypad		Premium Keypad
      	<ol style="list-style-type: none"> 1. Make sure there is nothing moving near the motion detector and that the READY light is on. (If it is not, see page 26.) <p>Press the OPTIONS key.</p> <ol style="list-style-type: none"> 2. Press the 2 key. <p>The ENTER CODE light blinks.</p> <ol style="list-style-type: none"> 3. Press 2, 4. Then, press and hold the 7 key for three seconds. * <ol style="list-style-type: none"> 4. Open each protected door and window. Listen for the siren to blast. Close the door or window. <ol style="list-style-type: none"> 5. Walk in front of the motion detector. <p>The siren blasts each time the motion detector detects your movements.</p>	<p>READ Y</p>  DOOR CHIME    	<ol style="list-style-type: none"> 1. Make sure there is nothing moving near the motion detector and that the message window reads READY. (If it does not, see page 26.) 2. Press the OPTIONS key until the message window reads DOOR CHIME. 3. Press 2, 4. Then, press and hold the 7 key for three seconds.* <p>The message window reads READY DOOR CHIME TEST.</p> <ol style="list-style-type: none"> 4. Open each protected door and window. Listen for the siren to blast. Close the door or window. 5. Walk in front of the motion detector. <p>The siren blasts each time the motion detector detects your movements.</p>

(continued)

	
 <p>1-800-445-0872</p> <p>CANCEL</p>	<p>6. If you do not hear the siren blast, call Brink's at 1-800-445-0872.</p> <p>7. When you have finished, press the CANCEL key.</p>

	
 <p>1-800-445-0872</p> <p>CANCEL</p>	<p>6. If you do not hear the siren blast, call Brink's at 1-800-445-0872.</p> <p>7. When you have finished, press the CANCEL key.</p>

***Note:** If the system has four-digit codes, press 2,4,7, then press and hold the 0 key for three seconds.

Testing the Smoke Detector

The smoke detector can be tested without sending an alarm signal to Brink's Monitoring Center. Call Brink's Customer Care at 1-800-445-0872 for assistance. Do not attempt to test the smoke detector with heat, flame, or canned smoke. These methods can damage the smoke detector.

Testing the Doors and Windows Only

This test identifies whether the sensors on your home's protected doors and windows are operating properly. You may prefer to conduct this test if you find it distracting to hear the siren blast each time you pass the motion detector during the test. **No alarm signals are sent to the Brink's Monitoring Center.**

To test the system's door and window sensors, follow the instructions on the next page. **NOTE:** If the system's chime feature is on, skip steps 2, 3, and 4 of the Standard Keypad instructions or steps 2 and 3 of the Premium Keypad instructions. When the chime feature is on, the keypad beeps if a protected door or window is opened while the system is off.



Standard Keypad



1. Close all doors and windows. Make sure that the READY light is on. (If it is not, see page 26.)



2. Press the OPTIONS key.



3. Press the 2 key.



4. Enter your code.
The READY and the CHIME lights turn on.





5. Open each protected door and window. Listen for the keypad to beep.*





1-800-445-0872

6. If you do not hear the keypad beep, note the zone number and call Customer Care at 1-800-445-0872.





7. When you have finished testing, end the test by repeating steps 2, 3, and 4.





Premium Keypad



1. Close all doors and windows. Make sure the message window reads READY. (If it does not, see page 26.)



2. Press the OPTIONS key until the message window reads: DOOR CHIME.

DOOR CHIME

3. Enter your code.
The message window reads READY DOOR CHIME.



4. Open each protected door and window, Listen for the keypad to beep.*



5. If you do not hear the keypad beep, note the zone number and call Customer Care at 1-800-445-0872.



1-800-445-0872

6. When you have finished testing, end the test by repeating steps 2 and 3.



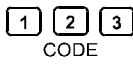











***Note:** The keypad does not beep if the chime feature has been turned off by the installer.

Testing With Not Ready Zones

If the system is not ready to test, the message window reads NOT READY or the READY light is off. Do the following:

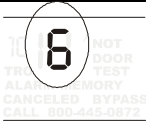
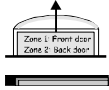
	Standard Keypad
	1. Press the OPTIONS key.
	2. Press the 7 key.
	3. Observe which zone number is displayed. This is the zone that is not ready.
	4. Refer to the Pop-Up Zone Card to verify the location of the zone.
	5. If the zone is a door or window, make sure that it is securely closed.
	6. If the READY light turns on, conduct the test.
	7. If the READY light does not turn on, call Brink's at 1-800-445-0872 for assistance.

	Premium Keypad
	1. Observe which zone number is displayed. This is the zone that is not ready.
	2. Refer to the Pop-Up Zone Card to verify the location of the zone.
	3. If the zone is a door or window, make sure that it is securely closed.
<p>READY</p>	4. If the message window now reads READY conduct the test.
	5. If the message window still reads NOT READY, call Customer Care at 1-800-445-0872 for assistance.

Trouble Messages

You will get a trouble message if the system loses power, if it cannot reset the smoke detector, or if it cannot contact the monitoring center.

Standard Keypad

1. If the TROUBLE light is on, press the OPTIONS key, then the 9 key. One of the keypad's zone lights blinks; compare it to the table below.

Blinking Zone LED	Trouble Condition	Page
1	Low battery	29
2	Communication Problem Indication	30
3	Zone Trouble Indication	32
4	Call Brink's Indication	32
5	Component Failure Indication	32
6	Siren Failure Indication	32
8	Line Cut Indication (optional feature)	31

2. Press the OPTIONS key and the 9 key once more. One of the keypad's zone lights may blink; compare it to the table below. If none of the conditions exist, the keypad returns to its normal state.

Blinking Zone LED	Trouble Condition	Page
1	Upload/Download Failure	31
2	No AC Power Indication	28

Premium Keypad

1. Observe which of the keypad's icons are lit, and note any letters that may appear in the numeric display. Match the keypad's message to the table below, then turn to the section listed in the table's second column for further information and instructions.

Message	Trouble Condition	Page
CALL 800-445-0872	Call Brink's Indication	32
CF TROUBLE	Component Failure Indication	32
CP TROUBLE	Communication Problem Indication	30
CS TROUBLE	Siren Failure Indication	32
CH TROUBLE	Upload/Download Failure	31
LINE CUT	Line Cut Indication (optional feature)	31
LOW BATT	Low Battery Indication	29
NO AC	No AC Power Indication	28
TROUBLE (beeping)	Zone Trouble Indication	32

No AC Power Indication

What it means: The electrical power to the system has been interrupted. Instead, the system is drawing power from its backup battery. The battery can provide power to the system for up to four hours.

What to do:

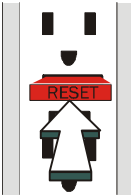
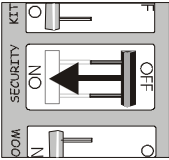
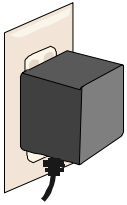

1. If you have no power to your home, wait for the electrical power to be restored. Once this happens, the system automatically switches back to its electrical source. The backup battery recharges for the next 24 hours.
2. If you have power to your home, check the power transformer to ensure that it is properly plugged in. (See page 5 for more information about the power transformer.)

If this solves the problem, stop. Otherwise, continue to the next step.

3. Check the breaker box. If any breakers are in the OFF position, move the breaker switch to ON.

If this solves the problem, stop. Otherwise, continue to the next step.

4. Look for a ground-fault circuit interrupter (GFCI) on the outlet, or on a nearby outlet. The GFCI should look similar to the one shown in the picture. If the red reset button juts out from the outlet, push it back into place.

If this solves the problem, stop. Otherwise, continue to the next step.

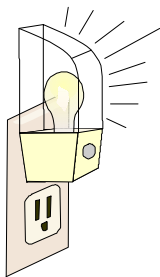

5. Unplug the power transformer. It may be screwed in place; if so, remove the screw. Plug a small appliance into the outlet to verify the outlet is working properly. If it is, continue to the next step.

If the outlet is not working properly, contact an electrician to repair it. Use an extension cord to plug the system's power transformer into another outlet, until the faulty one is repaired.



1-800-445-0872

6. If none of these steps resolve the problem, call Brink's Customer Care at 1-800-445-0872.

Low Battery Indication

What it means: The system's backup battery is low. If there has not been a power outage at your home recently, call Brink's Customer Care at 1-800-445-0872 for assistance. If there has been a recent power failure, follow the instructions below.

What to do:



1-800-445-0872

1. If you wish to silence the keypad's beeping, press the CANCEL key.
2. Once power to your home is restored, wait 24 hours for the battery to recharge.
3. If the trouble condition returns after 24 hours, the battery is not recharging properly. Call Brink's Customer Care at 1-800-445-0872 for assistance.

Note: if the system appears to have no power (the keypad does not light or respond to your commands), call Brink's Customer Care at 1-800-445-0872 for assistance.

Communication Problem Indication

What it means: The system was unable to send an alarm or test signal to the Brink's Monitoring Center.

What you'll notice: The keypad beeps four times per minute. If you have a Premium Keypad, the message window reads CP TROUBLE, CALL 800-445-0872.

What to do:

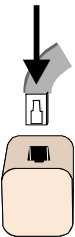
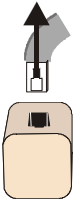

1. To silence the keypad's beeping, press the CANCEL key.
2. Check your telephone for a dial tone. If there is no dial tone, remove the dialer cable from the telephone jack. This disconnects the system from the telephone line. ***It will not be able to send an alarm signal to the Brink's Monitoring Center.***
3. Check your telephone for a dial tone. If the dial tone returns, call Brink's Customer Care at 1-800-445-0872 for assistance.
4. If there is no dial tone, ***plug the dialer cable back into the telephone jack.*** Contact your telephone company for service.

Until the telephone service is repaired, no alarm signals will be sent to Brink's. However, the system should still work within your home. ***For your protection, it is very important that you resolve this problem quickly.***

Line Cut Indication (Optional Feature)

What it means: The telephone service to the security system has been interrupted. The system cannot send an alarm signal to the Brink's Monitoring Center.

What you'll notice: Less than one minute after the line cut occurs, the siren sounds or the keypad beeps, depending on whether the system is on or off.

What to do:

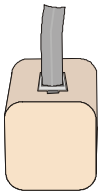

1. To silence the keypad's beeping, press the CANCEL key.
2. If the siren is sounding, silence it by entering your code.
3. Check your telephone for a dial tone. If there is no telephone service, contact your telephone company.
4. If there is a dial tone, ensure that the system's telephone cable is securely plugged into the telephone jack. If it is not, plug it in.
5. If the cable is plugged in, call Brink's Customer Care at 1-800-445-0872. Customer Care is ready to help you 24 hours a day, seven days a week.

Upload/Download Failure

A problem occurred when Brink's attempted to change or read your system's programming over the telephone line. Call Brink's Customer Care at 1-800-445-0872 for assistance.

Zone Trouble Indication

What it means: A trouble on a zone condition would arise if, for example, the smoke detector is dirty or is in need of adjustment. It could also occur if a sensor has a defective part or a broken wire.

What to do:



1. To silence the keypad's beeping, press the CANCEL key.
2. Wait 30 minutes for the system to reset.
3. If the detector has not reset after 30 minutes, the trouble message returns and the keypad beeps. Call Brink's Customer Care at 1-800-445-0872.

Component Failure

One of the system's devices is not operating properly. Call Brink's Customer Care at 1-800-445-0872 for assistance.

Call Brink's Indication

If you receive this trouble message, call Brink's Customer Care at 1-800-445-0872 for assistance.

Siren Failure Indication

The system's siren is not operating properly. Call Brink's Customer Care at 1-800-445-0872 for assistance.

Keypad Not Working (Speaker Clicks)

Should the system's keypad become inoperative, the speaker sounds two short clicks every three seconds. If you notice the speaker is clicking repeatedly, call Brink's Customer Care at 1-800-445-0872 to arrange to have the keypad serviced. If the system has a second keypad that is operating normally, you can stop the clicking sound by pressing the CANCEL key.

Cleaning the Smoke Detector



Vacuum once every three months

If you had a smoke/heat detector installed, you should clean it once every three months. You should also clean it if smoke or dust triggers an alarm.

Vacuum the smoke detector vents using a crevice attachment. Do not remove the cover.

If You Trigger an Alarm while Cleaning the Detector

If the dust from your vacuum cleaner triggers an alarm and the siren sounds, do the following:



CODE



1-800-445-0872

1. Enter your user code.
2. Press the CANCEL key.
3. Finish vacuuming the detector.

If the keypad is beeping and the message window reads TROUBLE, wait 30 minutes for the system to reset.

4. If you wish to silence the keypad's beeping for the next four hours, press the CANCEL key.
5. If the detector does not reset after 30 minutes, the message window reads "TROUBLE, CALL 1-800-445-0872" and the keypad beeps. Call Brink's Customer Care at 1-800-445-0872.

Service the Detector Every Two Years

Every two years, you should contact Brink's Customer Care to schedule a visit to service the smoke detector. During this call, Brink's does a more thorough cleaning and testing of the detector.

Setting the Clock



Clock,
Premium Keypad

The numeric display of your Premium Keypad may show the time of day. You do not need to set the clock; it adjusts itself automatically every few months. However, if the time is incorrect, you can correct it by pressing and holding the 0 key for ten seconds. The keypad's display goes blank for ten seconds, and then the system makes a brief telephone call to Brink's, obtains the actual time, and resets the clock.

While the system is making this short call, you will not be able to use your telephone.

Emergency Evacuation Plans

An emergency evacuation plan helps to ensure that you and your family escape from your home safely in the event of a fire. Use these guidelines from the National Fire Protection Association to prepare your own emergency evacuation plan.

1. Draw up a floor plan of your building, like the one shown. Show any part of the building—the windows, doors, rooftops—that can be used as an escape route.

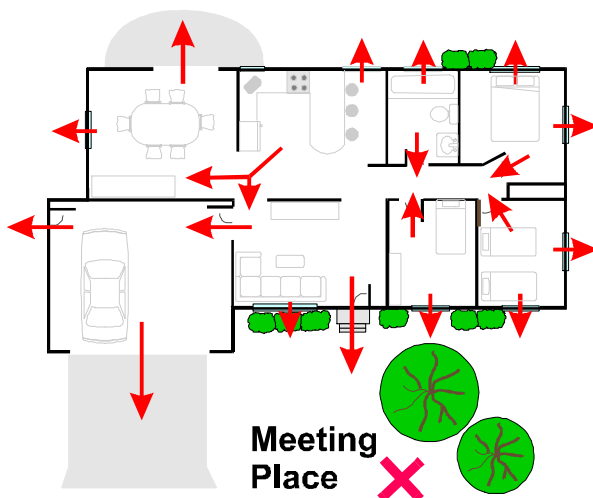

Find at least two ways to escape from each room. One will be the door leading to the normal exit. Another may be a window that opens easily. If the window is high off the ground, you may need to install an escape ladder nearby. Identify a place outdoors where everyone is to meet after leaving the building.

2. Review the escape plan with everyone who lives in your home and practice escape procedures.
3. To increase the time you will have to escape a fire, sleep with your bedroom door closed. If you suspect a fire, touch the door. Do not open the door if it feels hot. If it does not, brace your shoulder against the door and open it slowly. Be ready to slam the door if smoke or heat rush in. Leave the building quickly and call the fire department from a neighbor's telephone, or from your cellular telephone.

In the event of a fire, the best way to ensure the safety of your family is to get the earliest possible warning. This is best achieved by installing fire detection equipment in all rooms and areas of the house. This includes:

- a smoke detector installed outside of each of the bedrooms
- heat or smoke detectors in the living room, dining room, kitchen, hallways, attic, furnace room, closets, utility and storage rooms, basement, and garage.

This equipment should be installed in accordance with the National Fire Protection Association's Standard 72.

For additional information, write:

National Fire Protection Association
1 Battery March Park
Quincy, MA 02269

California residents may also write:

California State Fire Marshal
7171 Bowling Drive, Suite 600
Sacramento, CA 95823

Questions and Answers

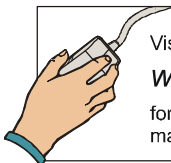

Visit the Frequently Asked Questions page of
www.mybrinks.com
for more answers to the questions you
may have about the Brink's security system.

General Use of the System

1. How can I avoid false alarms?

Take a look at the tips on page 3. If you have any further questions, call Brink's Customer Care at 1-800-445-0872. Customer Care is available to help you 24 hours a day, seven days a week.

2. Do I need an alarm permit?

Alarm permit ordinances vary from area to area. Please contact your local emergency agencies, or your city or county government to determine if a permit is needed in your area. It is your responsibility to get the permit, pay the fees, and inform Brink's of your permit number.

If you do not have a permit, emergency agencies may choose not to respond to an alarm at your home. In addition, false alarm fines are generally much higher for systems lacking permits.

3. How often should I test the system?

You should test the system once a week. Follow the test instructions beginning on page 22 of this manual.

4. Should I clean the smoke/heat detector?

Yes. Follow the instructions on page 13.

5. What happens if I add DSL (digital subscriber line) service to my home?

Converting your telephone line to a high-speed data format like DSL can affect the ability of the system to report alarm conditions to the Brink's Monitoring Center. See page 42 for more information.

Codes and Code Words

1. Can my master code number be changed?

Yes. Notify Brink's Customer Care at 1-800-445-0872 to set up the change. Customer Care is ready to help you 24 hours a day, seven days a week. A service charge will be assessed for this request.

2. How do I change my master code word?

The same person who signed the Protective Service Agreement must send a written request to Brink's before the master code word can be changed. The written request must identify the account, the current master code word, the new master code word, and the writer's signature. The request should be mailed to: Brink's Home Security, Customer Care Department, 8880 Esters Boulevard, Irving, TX 75063. The new code word must be three to five characters in length.

If there is an immediate need to change your master code word, call Brink's Customer Care to obtain Brink's fax number.

3. I'm planning to go away on vacation. Should I notify Brink's of my plans?

Yes. You can do this by filling out the My Vacation Notes form at www.mybrinks.com or by calling Customer Care at 1-800-445-0872. Brink's will need to know when you plan to leave, and when you will return, as well as who to contact in the case of an emergency. Your emergency contact may be asked to go to the house to secure it, or to meet the police at the house in the event of an emergency. Be sure that this person has a set of house keys, and knows a user code and a code word.

4. If I go away on vacation, should I give my master code to my neighbor who takes care of the house?

It is best not to give out your master code or code word. Instead, you can program an auxiliary code for your neighbor to use. See the instructions on page on page 19. You can also add an auxiliary code word by calling Brink's Customer Care at 1-800-445-0872. Be sure to give your emergency contact(s) a telephone number where you can be reached while you are away.

Alarms and Emergencies

1. If there is an alarm, does the system reset?

Yes, as long as there are no additional alarms after the system stops sounding. The system resets itself approximately five minutes later. ***However, if a fire alarm is activated, the siren will sound continuously until you enter your user code.***

2. What happens if my telephone line is cut?

If you purchased the optional Line Cut feature, the siren sounds or the keypad beeps within about a minute of the time the line was cut. The system can still sound an audible alarm but the Monitoring Center will not receive an alarm signal until the line is restored.

You can also equip the system with an optional backup device that is designed to send a signal if the telephone service is interrupted. Contact Brink's Customer Care at 1-800-445-0872 for more information.

3. If the power goes out at my house, will my alarm system still work?

Yes. The system has a battery that can provide back-up power for up to four hours. Once the electrical power to your home is restored, the battery recharges automatically. Like all batteries, this battery will eventually need to be replaced. To replace the battery, call Brink's Customer Care at 1-800-445-0872 to schedule a service call. If you purchased an extended service plan, there will be no charge for this service.

Emergency Contacts

1. Who should I list as an emergency contact?

You should list people who live fairly close to you and who usually know where you are and how to contact you. Ideally, at least one of your contacts should have keys to your house and permission to authorize service in your absence. You can change your list of emergency contacts by logging on to the

Update My Alarm Contacts List at www.mybrinks.com or by calling Brink's Customer Care at 1-800-445-0872.

2. What should I tell my emergency contacts?

First of all, be sure to tell them that they are one of your emergency contacts. Tell them that, after the emergency agencies are notified, Brink's may attempt to reach them when there is an alarm at your house. Discuss what action you would like them to take if this happens. You should also tell your emergency contacts if they have your permission to authorize service of the system in your absence.

On occasion, representatives of an emergency agency may ask your emergency contact to meet them at the house with the house keys. Emergency contacts, however, should **never** attempt to investigate an alarm independent of the authorities.

3. How do I change my emergency contacts?

Log on to the Update My Alarm Contacts List at www.mybrinks.com or call Brink's Customer Care. Be prepared to give your code word and provide the updated information.

Financial Questions

1. Who pays false alarms fines?

Because the vast majority of false alarms are outside of Brink's control, we require you to be responsible for all of your false alarm fines.

2. What if I move within the initial term of my contract?

You may have the system moved to another residence, provided we service the area and you pay the applicable move charge. The new owner of the home may take over the system by signing a new agreement and paying our current reprogramming fee. This will release you from the remaining contract obligations. If the new owner does not wish to take over the system, and you do not choose to move the system, you will be responsible for the original contractual obligation.

3. Do I own the system?

If you paid the connection fee only, Brink's owns the alarm system. If you paid the additional purchase charge, you own the system. If you purchased the system, your installation work order will show a separate "Purchase Fee" of usually an additional \$500.

4. Will I receive a discount on my insurance for having a security system installed?

Most homeowner's policies offer discounts to policy holders with security systems. Contact your insurance company for more information. The Certificate of Installation that your installer provided can be used to provide proof to your insurance company that the installation took place.

5. How do I receive credit for referring another customer?

If you refer a new customer to Brink's, and that customer has a Brink's Home Security system installed, you will receive one month of monitoring free. Please have the person you referred write your name and telephone number in the space provided at the bottom of their contract. Contact Brink's Customer Care at www.mybrinks.com or call 1-800-445-0872. Your account will be credited within 60 days of the installation date.

6. What taxes do I have to pay?

Taxes vary from region to region. Most states require the collection of a sales tax on the equipment you purchase. Some states require an additional service tax on the installation, monitoring, and repair services you receive. Also, unless you own Protective Equipment, Brink's will bill you once a year for the property tax assessed by your local taxing authority. This tax is generally less than \$15.

7. Do I pay for service calls and repairs?

Repair service during the first 90 days is free of charge. After the first 90 days, we charge for labor. If you prefer, you can purchase a service plan from Brink's, to continue to receive free repairs after the first 90 days.

Normal service hours are 8:00 AM to 5:00 PM, Monday through Friday. A premium rate is charged for service calls on weekends, holidays, or after hours.

Repairs and Upgrades

1. Can I make an appointment for a service call?

Our service center schedules service calls for the morning or afternoon of a specific day. Morning service calls occur between 8:00 AM and 12:00 PM. Afternoon calls occur between 12:00 PM and 4:00 PM.

2. Can I have additional equipment installed at a later date?

Yes, additional equipment may be installed. You will be charged for the installation and for the service call. If you choose to have the equipment installed initially, however, you will not be charged for a service call. You can learn more about the wide variety of additional equipment that is available at www.mybrinks.com.

Additional Questions?

If you have other questions about the system, please contact Customer Care at 1-800-445-0872 or write:

Brink's Home Security
Customer Care Department
8880 Esters Boulevard
Irving, TX 75063
www.mybrinks.com

Warranty Information

This manual does not create any additional expressed or implied warranties.

Important Notices

UL Information

This system is capable of providing either Grade A or Grade B service for residential burglary. If configured to Grade B, performance of a weekly test as indicated in this manual is necessary. Contact Brink's for more details on your particular installation. Accessories which do not bear the UL mark have not been investigated with this system by Underwriter's Laboratories, Inc.

DSL service

If you convert your telephone line to a high-speed data format (such as DSL), it could affect the ability of the security system to transmit signals to the Brink's Monitoring Center. If you have switched to such a service, you should immediately conduct the Siren and Transmission Test described on page 22. If the test is not successful, call Brink's Customer Care at 1-800-445-0872. Brink's may need to install a filter provided by **your** DSL company to restore communication. However, because of the nature of DSL service you should be aware that, even with this filter installed, the system will not be able to communicate with the Brink's Monitoring Center any time that your telephone is in use or off the hook. For more information, visit www.mybrinks.com.

Alarm Permits

Your local municipality may require you to obtain an alarm permit before you can operate the Brink's Home Security system. Please contact your city or county police department to determine the requirements in your area. For more information, visit www.mybrinks.com.

If you have questions about the
Brink's Home Security system

visit:

www.mybrinks.com

or call Brink's Customer Care
at 1(800) 445-0872, 24
hours a day, seven days
a week.



Copyright © 2001, IntelliSense®



5-051-772-00 Rev A